



HOSHIZAKI

Leading Naturally

Ice Makers, Dispensers & Crushers | Storage Bins & Transport Systems | Sushi Cases



HOSHIZAKI

C o n t e n t s



About Us	3
Built on Strong Foundations	4
Environmental Preservation	6
Our Quality Marks	8
Product Code Definitions	10
Ice Makers	13
Ice For all Reasons	14
Ice Types	15
Ice Sizes & Shapes	16
NEW Emerald Class Ice Makers	18
IM Range	21
IM Product Highlights	22
IM Emerald Class	24
IM-N Series	27
IM Special and Cylinder Ice Makers	32
FM Range	35
FM Product Highlights	36
FM Emerald Class	38
FM Ice Makers	40
KM Range	47
KM Product Highlights	48
KM Crescent Ice Makers	50
NEW AM COMPACT Ice Maker	55
Ice and/or Water Dispensers	57
DCM Product Highlights	58
DIM Product Highlights	60
DSM Product Highlights	61
Bins, Transport Systems, Crushers	63
Storage Bins	64
Top Kits	66
Transport Systems	68
Ice Bagging & Dispensing Systems	68
Ice Crushers	69
Sushi Cases	71
Sushi Cases Product Highlights	72

Photography by Benjamin Brette www.bphoto.fr (p12,13,20,23)



Built on Strong Foundations

Mission Statement -

Hoshizaki Electric Co. Ltd.

We, Hoshizaki Group, aim to be an “Evolving Company” contributing to society as well as customers, meeting the changing needs and demands for diversified “Eating”.

To achieve the above, we develop original products incorporating original technology. And we present innovative proposals for a more comfortable and efficient eating environment and offer responsive, high quality services.

Our Corporate Philosophy

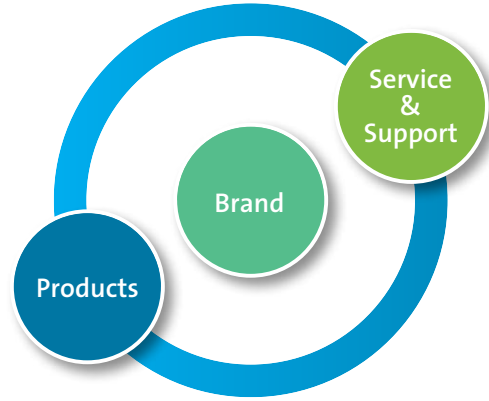

Hoshizaki Group Historical Timeline

Overseas Expansion

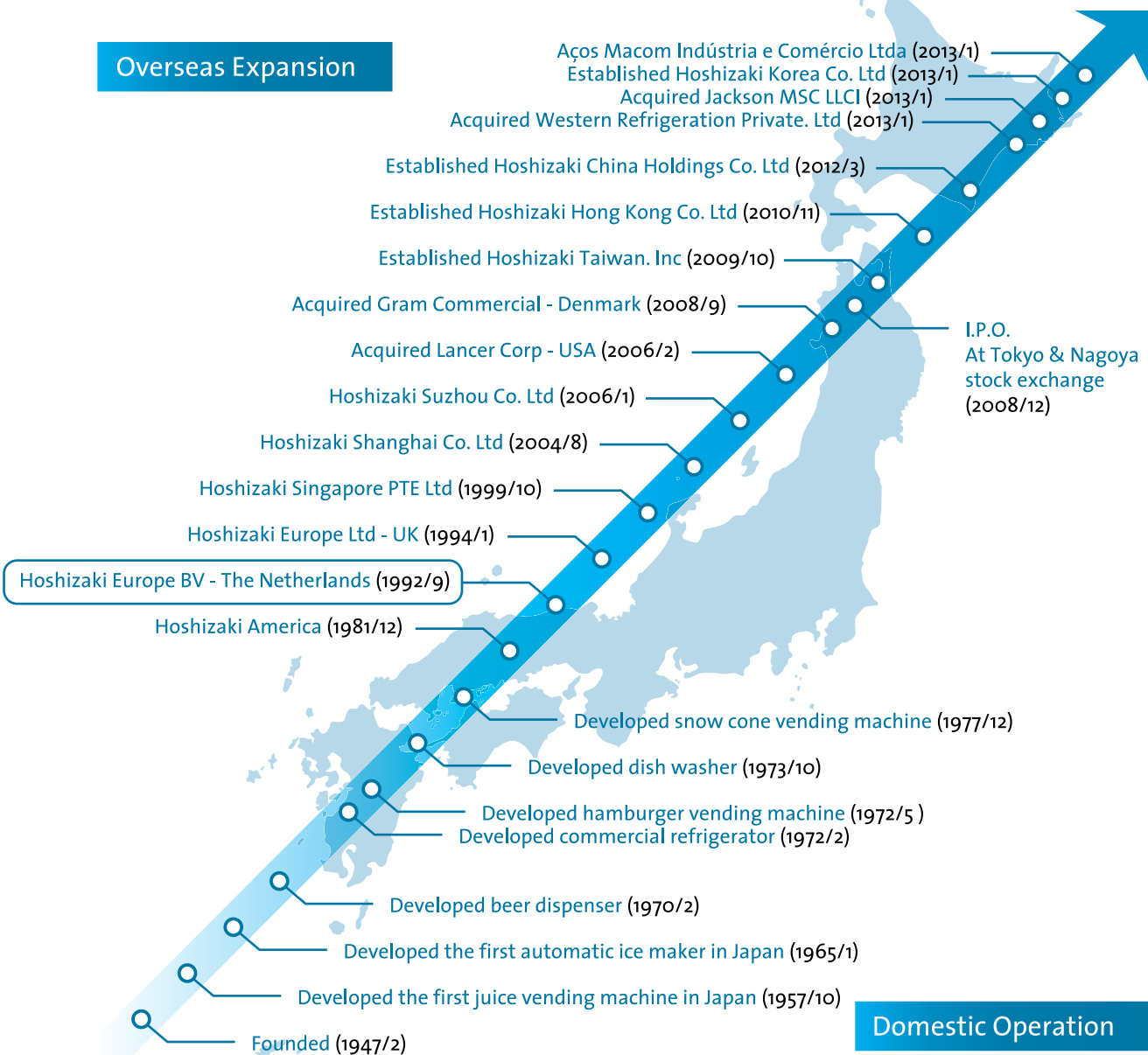

Domestic Operation



Our Cool and Clean Mission

With almost 70 years of experience in the commercial kitchen equipment and food service markets, Hoshizaki has become a global market leader.

In 1965, we designed and developed Japan's first fully automatic ice maker and from this pioneering base we have an ice making and refrigeration product portfolio that exceeds expectations in the demanding of food, beverage, bars and restaurants, bio-science, healthcare, marine and education.

Hoshizaki has rightfully gained an international reputation for sustainable innovation, durability and reliability. All machines are designed and specified by Hoshizaki's dedicated Japanese Research and Development team, which ensures Hoshizaki continues to devise innovative and sustainable products that cement the company's position as one of the world's visionary suppliers.

The Markets We Serve



Catering



Hospitality



Marine



Food Processing



Laboratory



Healthcare



Education



Leisure





Environmental Preservation...

“Good products come from a good environment”.

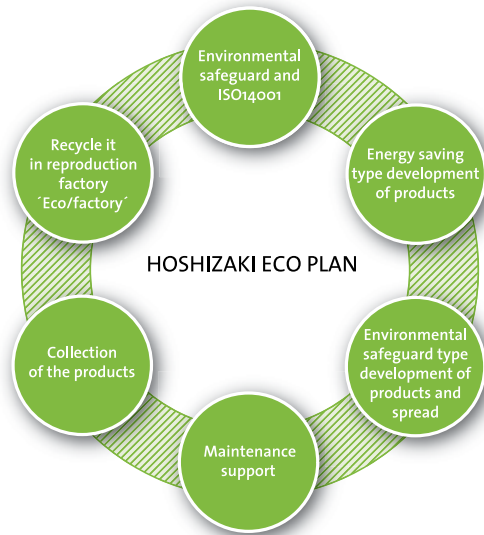

- This is a pledge that Hoshizaki respects at all times in the management of our factories. Based on this management concept, we put first priority on HARMONY with the local natural environment whenever building a new factory.
- We are pursuing efforts to preserve the environment with measurements such as the 'Eco Plan' a long-running program intended to counter global warming and deal with other environmental problems.
- The Hoshizaki Eco plan, is an integrated program combining efforts in product development, recycling, recovery of environmentally-impacting CFC's and various other environmental measures.

Did you know?

The Hoshizaki Green Foundation was established in May 1990 as a special public interest promotion corporation with the objective of “implementing projects to protect and propagate wild plants and animals. Hoshizaki will continue to aid the Hoshizaki Green Foundation’s work in protecting wildlife and preserve the natural environment while supporting the Foundation’s investigative research and nature protection and educational projects.



Preserving an Avian Paradise
Shinjiko Green Park

Opened: June 6 1996

Area: 16,000 sqm

No. of trees: Approx. 5,500



Source: Hoshizaki Electric Co. Ltd

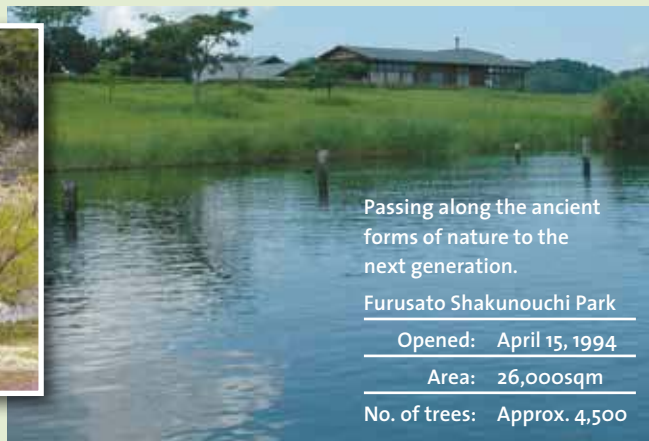

Passing along the ancient forms of nature to the next generation.

Furusato Shakunouchi Park

Opened: April 15, 1994

Area: 26,000sqm

No. of trees: Approx. 4,500



...an Important Hoshizaki Mission.

Natural Refrigeration

Believing that natural refrigerants will play a major part within the future of refrigeration technology, Hoshizaki has committed to take a leading role in the design and manufacture of environmentally positive ice makers and refrigerators.



**NATURAL
REFRIGERANT
R290**

EU Legislation

Why has the industry been so pro-active with adapting the technology?

Legislation has played its part in fuelling the uptake of natural refrigerants. The issue is already high on the agenda for companies such as Hoshizaki that want to future-proof their businesses.

The European Union has a strong commitment to protect the ozone layer and has put in place legislation that is among the strictest and most advanced in the world. Europe has not only implemented what has been agreed under the Montreal Protocol on protecting the ozone layer but has often phased out dangerous substances faster than required.

NEW



Emerald Class ICEMAKERS

Hoshizaki is proud to launch the Emerald Class.

- Comprises Cube, Flake and Nugget Ice makers.
- Utilises Natural Refrigerant R290. Global Warming Potential of (<5).
- Improved energy performance, which helps generate savings.
- HACCP certified.

Find out more see pages 18-19, 24-26 and 38-39.



Why Emerald?

The power of the Emerald crystal symbolises hope, new life and the power of nature's constant renewal. The dynamic green color represents our commitment to environmental preservation.





Our Quality Marks



- HACCP is a risk management tool recognized internationally for use in the proactive management of food and beverage safety issues.
- Hazard Analysis Critical Control Point (HACCP) is the main platform for International legislation and good manufacturing practices for all sectors of the food and beverage industry.
- The HACCP International Certification applies to the IM, FM/CM, KM, DCM series and the COMPACT AM-20CAE.



- ISO 9001 certification represents a formal acknowledgment by an accreditation organization that a company meets the intent of quality management standards issued by the International Organization for Standardization.
- A company receives this award after successfully passing an audit examining how well the standards were implemented and verifying the compliance of the company's employees to the guidelines.
- ISO 9001 aims at implementing processes that ensure customer satisfaction on a continuous basis.
- The ISO 9001 certification applies to both Hoshizaki's IM and FM series of ice makers.



- CE Marking on a product is a manufacturer's declaration that the product complies with the essential requirements of the relevant European health, safety and environmental protection legislation in place.
- CE Marking on a product ensures the free movement of the product within the EFTA & European Union (EU) single market (28 countries).
- CE Marking on a product permits the withdrawal of the non-conforming products by customs and enforcement/vigilance authorities.



- In the UK, Hoshizaki's IM, FM ice makers and DIM-30 dispensers are in compliance with WRAS.
- The purpose of WRAS is to contribute to the protection of public health by preventing contamination of public water supplies.
- WRAS directive encourages the efficient use of water by promoting and facilitating compliance with the Water Supply (Water Fittings) Regulations and Scottish Water Byelaws.

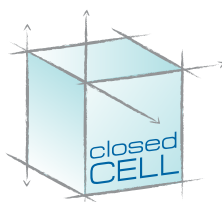

- Developed for Hoshizaki's IM-Range.
- Closed Cell System helps produce compact, hard and geometrically perfect ice.
- The hardness of the IM-Range ice ensures a low melt grade.



- Hoshizaki's KM Range (Crescent Shaped Ice) produces the same quantity of ice in half as many cycles as competitor brands.
- Fewer cycles per day results in increased life & profits. It will take a Hoshizaki ice maker 15 years to accumulate as many cycles as the competition in 6 years.
- Reduced operating cycles by half in 24 hrs, while producing the same quantity of ice compared to competitors.



- The system EverCheck is specifically developed for the KM Range.
- It gives a visible and audible alarm when maintenance assistance is required.
- Majority of all service and maintenance can be accomplished from the front.
- These controls are also located in a dry environment, greatly improving electrical component reliability.
- User friendly Electronic control.
- Reduces down-time.



- Developed for Hoshizaki's FM Range.
- This system extracts impurities and minerals from the water, making the produced ice cleaner.



- RoHS is the acronym for Restriction of Hazardous Substances and is a product level compliance.
- Also known as Directive 2002/95/EC. Originated in the European Union.
- Restricts the use of specific hazardous materials (e.g. cadmium, lead, and mercury), found in electrical and electronic products.
- The restricted materials are hazardous to the environment and pollute landfills, and are dangerous in terms of occupational exposure during manufacturing and recycling.
- All applicable products in the EU market after July 1, 2006 must pass RoHS compliance.



- Hoshizaki believes that natural refrigerants will play a major part within the future of refrigeration technology.
- Hoshizaki is committed to take a leading role in the design and manufacture of environmentally positive ice makers and refrigerators.
- All ice makers using Natural Refrigerant R290 are labelled with this mark. Our development team is continuously striving to expand our environmentally friendly product solutions.

Leading Naturally



Product Code Definitions

Model codes - IM Range

IM - 240 ANE - HC - 23

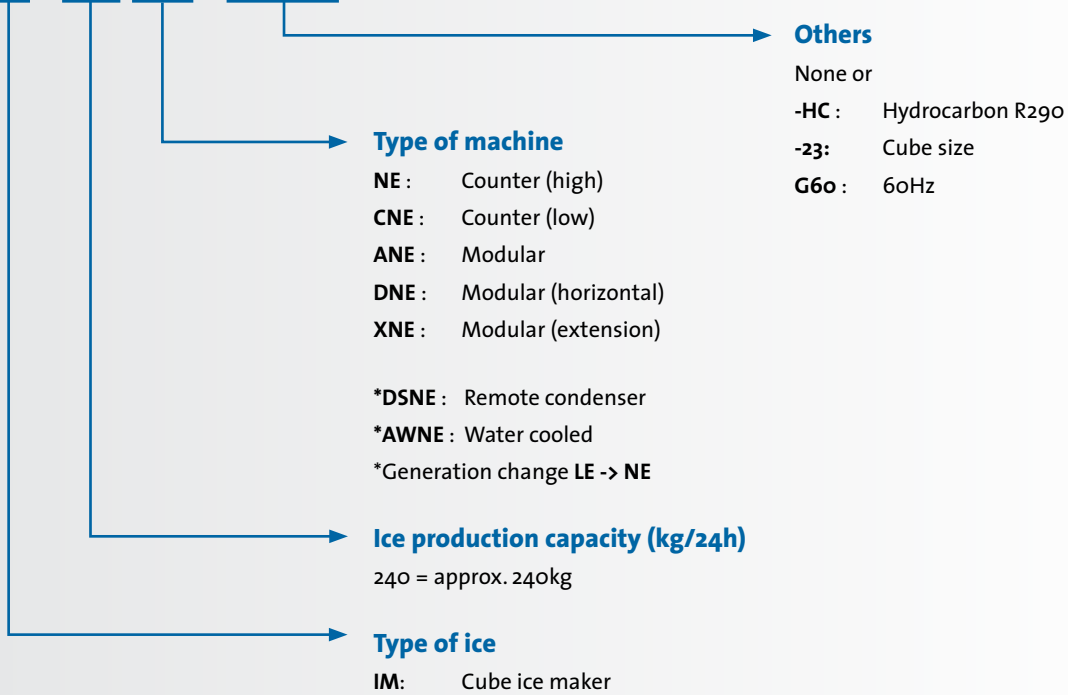

Model codes - FM Range

FM - 300 AKE - HCN - SB

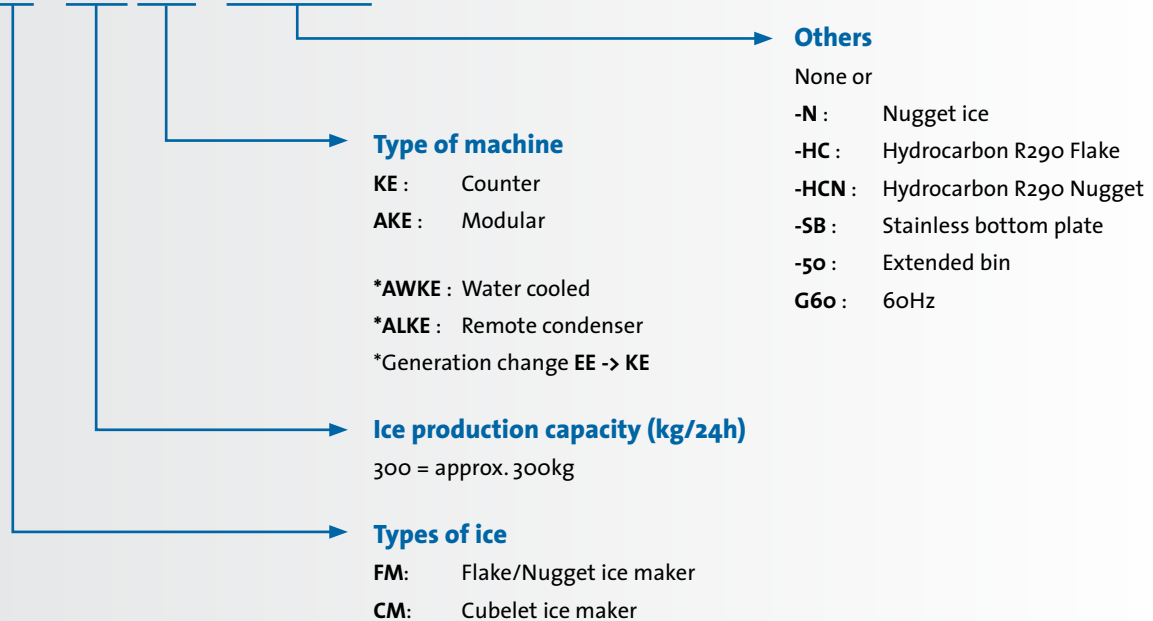



Model codes - KM Range

KM - 125 A

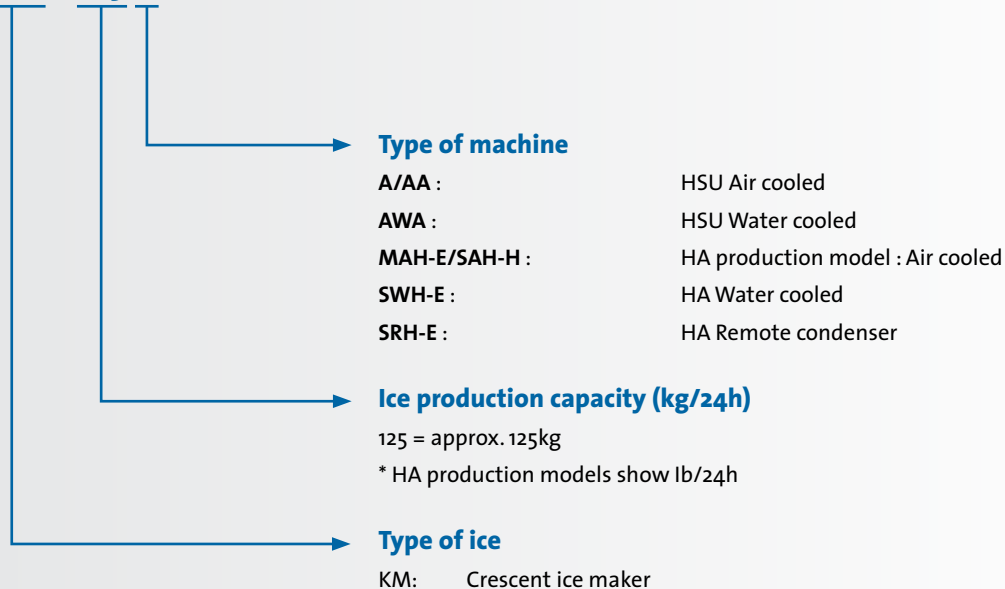

Model codes - HNC Sushi Cases

HNC - 210 BE - L - B G6o

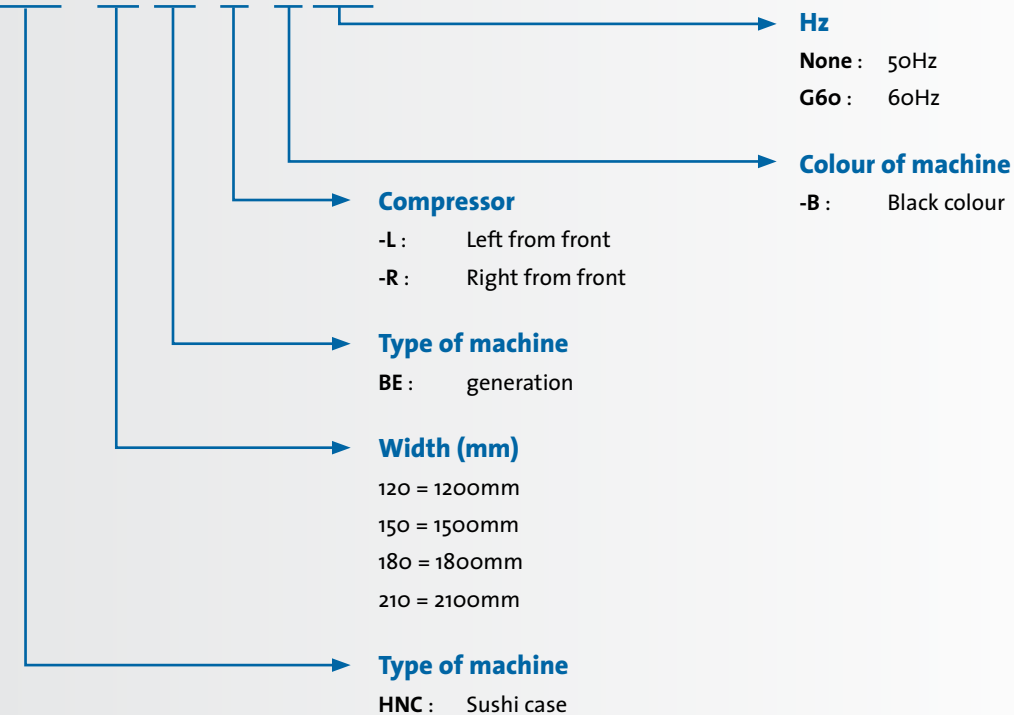





Ice Makers





Ice For All Reasons

Hoshizaki's wide range of ice makers caters for a host of requirements and we have developed innovative solutions that are tailored to the demands of a wide range of locations and operations.

We call upon our vast technical know-how and end-user knowledge to design and develop ice makers for the production of a variety of ice types, in addition to ice dispensers. You will see Hoshizaki ice making equipment and ice dispensing systems in front-of-house and back-of-house locations at the world's leading bar and restaurant

brands, and you are just as likely to find them performing critical functions on a deep sea fishing vessel.

Our ice makers are renowned for their outstanding performance and durability to withstand the toughest commercial pressures. The basic designs and major component parts are specified for a global market meaning that Hoshizaki machines will effortlessly and quickly achieve outstanding levels of efficiency in ambient temperatures of between 5°C and 40°C, even in humid environments.

Market Segments		IM							KM	FM		DSM	DCM	IM Special Range				AM
		Cube XS	Cube S	Cube M	Cube L STANDARD	Cube XL	Big Cube	Cylinder		Crescent	Flake			Nugget	Shuttle	Cubelet	Ball	
Hospitality	Bar/Café	x	x	x	x	x	x	x		x		x	x	x	x	x	x	x
	Cocktail	x	x	x	x	x	x		x		x		x	x	x	x	x	x
	Hotel	x	x	x	x	x			x	x	x	x	x	x	x	x	x	x
	Restaurants	x	x	x	x	x		x	x	x		x						
	Fastfood	x	x	x	x				x		x		x					x
	Nightclub		x	x	x	x	x	x	x		x			x	x	x	x	
Catering		x	x	x	x	x			x	x	x							x
Education		x	x	x	x				x		x		x					x
Healthcare	Laboratory								x	x	x	x						
	Hospital	x	x	x	x				x		x	x	x					
	Laser Therapy								x									
	Physiotherapy	x							x	x	x							
Food Processing	Packaged Food Display									x	x							
	Fresh Produce Display								x	x	x							
Marine			x	x	x		x		x	x	x	x	x	x	x	x	x	x
Leisure		x	x	x	x				x		x							x

EXCLUSIONS: DIM-30DE-1 produces Cube Ice for Hospitality Industry. CRUSHER produces Crushed Ice for Cocktail.

Ice Types

Regular Ice Types



Type: Cube Ice

Product Range: IM, DIM



Type: Cylinder Ice

Product Range: IM-C*



Type: Crescent Ice

Product Range: KM



Type: Shuttle Ice

Product Range: DSM



Type: Flake(F) / Nugget(N) Ice

Product Range: FM



Type: Cubelet

Product Range: DCM, CM(FM)

Special Ice Types



Type: Ball Ice

Product: IM-65NE-Q



Type: Star Shaped

Product: IM-65NE-S*



Type: Heart Shaped

Product: IM-65NE-H*



Type: Big Cube

Product: IM-65NE-LM*



Type: Long Cube

Product: IM-65NE-LM103*

*Longer Delivery times apply for special models.

NEW



Type: Top Hat Ice

Product Range: AM

Small in a Big Way

Undercounter model, suitable for small applications.



AM-20CAE COMPACT Ice maker



Ice Sizes & Shapes

Ice Sizes listed are approximations.

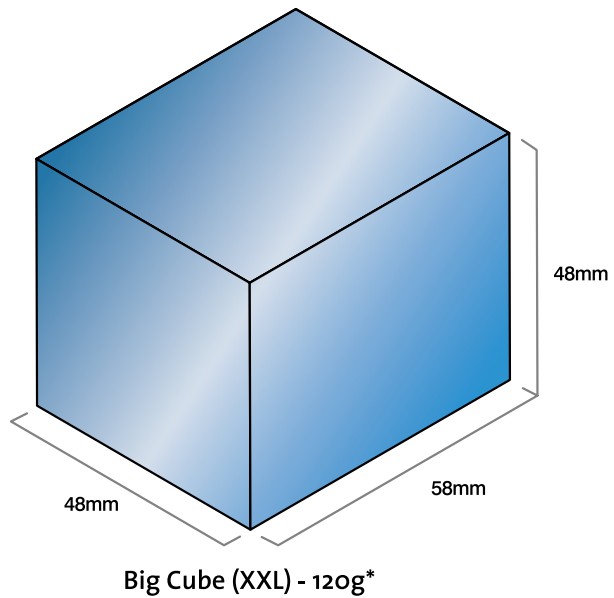
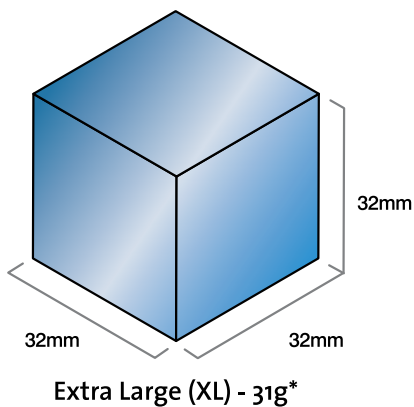
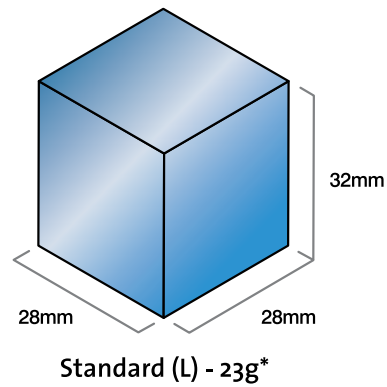
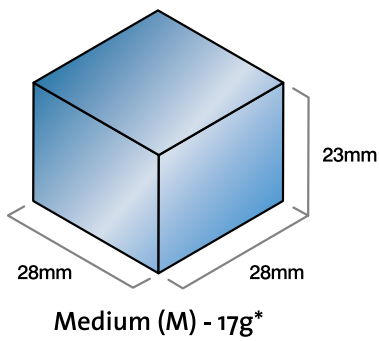
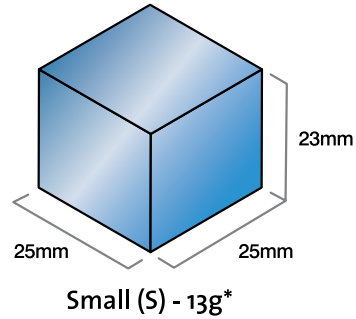
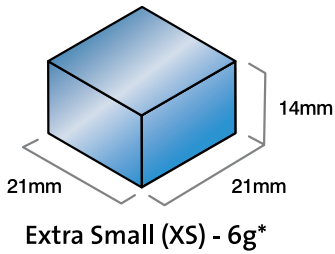

*Size of Ice Cube is reflected in product names of the IM Range.

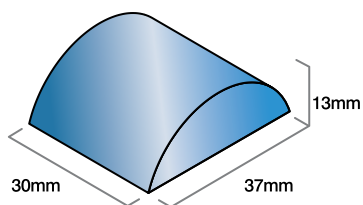

Crescent - 9g

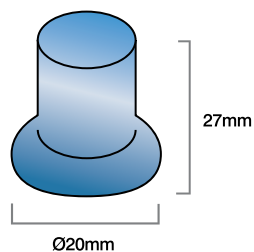

Top Hat - 13g

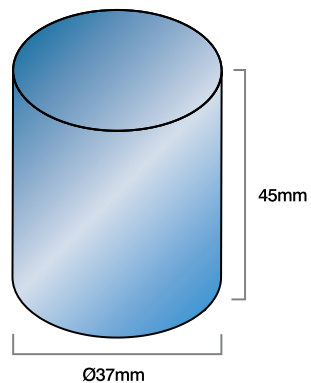

Cylinder - 42g

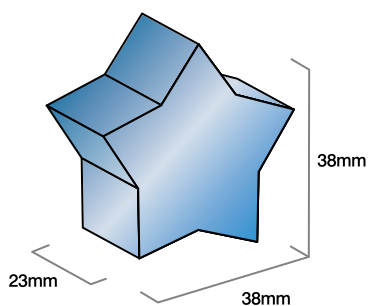

Star - 18g

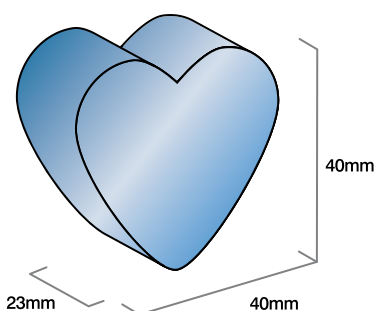

Heart - 25g

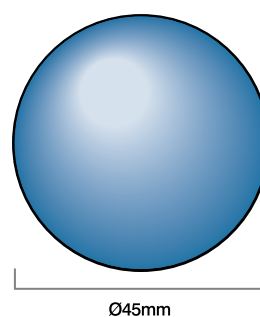

Ball - 45g

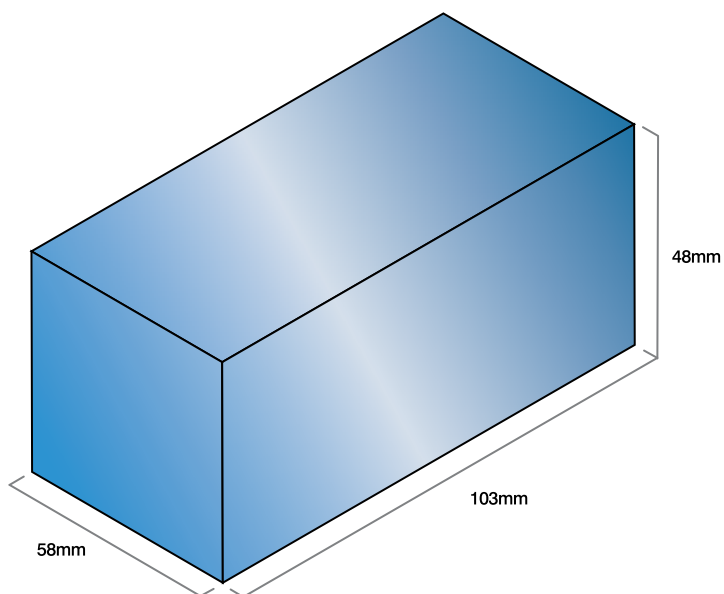

Long Cube (XXXL) - 240g

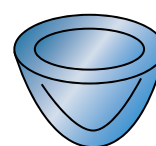

Shuttle - 3g

Please Note: Flake and Nugget Ice are excluded.



NEW

Emerald Class

ICEMAKERS

Hoshizaki launches the first phase of its new Emerald Class.

We are committed in helping businesses and individuals save money and protect our climate. The new class symbolises our commitment.

See table below. More models will be added in the near future.

Models

IM-21CNE-HC	Available
IM-30CNE-HC	Available
IM-45CNE-HC	Coming Soon
IM-45NE-HC	Coming Soon
IM-65NE-HC	Coming Soon
IM-100NE-HC	Available
IM-130ANE-HC	Available
IM-240ANE-HC	Available
FM-170EE-HC/HCN	Available
FM-170EE-50-HC/HCN	Available
FM-300AKE-HC/HCN-SB	Available
FM-480AKE-HC/HCN-SB	Available

Why Natural Refrigerants? Why Hydrocarbon R290?

Hydrocarbons (HC's) are naturally occurring substances that have proven to be some of the most climate-friendly and cost-efficient refrigerants to heat, cool and freeze.



**NATURAL
REFRIGERANT
R290**

Advantages of Hydrocarbon natural refrigerants include:

- Good compatibility with components.
- Low charges allowing smaller heat exchangers and piping dimensions.
- Very low global warming potential (<5).
- Excellent energy efficiency.

The Markets Served





Energy & Cost Savings 41,5%

Hydrocarbon Technology with Big Sustainability Credentials

EXAMPLE

The Modular IM-24oANE-HC

The IM-24oANE-HC is a modular ice maker that produces up to 235kg of Cube Ice per 24hrs.

Uses 147g of R290 Hydrocarbon complying with Standard EN60335-2-24, allowable charge of 150g.

How does the IM-24oANE-HC compare?

We have compared two models using the same ice production but with different gases: Hydrofluorocarbon (HFC), and the eco-friendly HFC-free Hydrocarbon gas.

Energy Savings Calculation

An example calculation has been made comparing the IM-24oANE and the HFC free IM-24oANE-HC. ice consumption of 100kg is used for the purpose of comparison.

Analysis:

The HFC free IM-24oANE-HC outperforms the IM-24oANE-HFC, demonstrating both operational and environmental benefits.

Hoshizaki's IM-24oANE-HC consumes:

- 8.2 kWh/100kg less energy.*
- 7014.28kW less energy p/a.*
- IM-24oANE-HC uses **41.5%** less energy.*

Please contact your local sales branch to receive your own cost savings calculation (based on local/national utility costs).



*Figures above are based on internal research and comparisons between Hoshizaki models (Production Capacity (kg/24h): AT 32°C, WT 21°C).





IM Range



Please visit our website to view our trading terms and conditions.



IM Product Highlights

The unique IM Range of Ice Makers is designed with hygiene as a priority. Each ice cycle is made with fresh water, ensuring only the highest quality of ice is produced. This is particularly important for ice that is used in premium beverages like cocktails, as it protects the integrity and flavour of the drink.



- Hoshizaki IM Ice makers utilise an ice making system that has an automatic rinse cycle. After every new batch of ice, the water reservoir will drain and refill with fresh water. The system comes with a magnetic water pump that has no direct coupling, which prevents any leakage.



- A stainless steel exterior with integrated door handles provides a hygienic and high quality finish.



- Removable door gaskets prevent any heat and contamination from entering the bin and make the Hoshizaki product easy to clean and maintain.



- A closed water circuit offers the ultimate contamination protection, by reducing the number of points at which impurities can enter the ice making process.



- An easily cleanable air filter allows users to carry out a routine cleaning schedule themselves, extending the life expectancy of your Hoshizaki ice maker, and cutting the frequency and cost of maintenance call-outs.



- Ice makers are electronically controlled so the ice making process is optimised under varying circumstances without the need for physical adjustments. This means the quality of ice is always consistent.
- The natural foaming agent insulates and preserves the quality and consistency of the ice produced longer than any other machine available. This reduces the number of production cycles, saving energy and money.

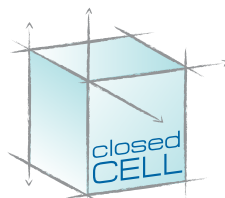

Our Unique Closed Cell System

The Ice Production Process



With the water plate closed against the underside of the evaporator, the water circuit is closed to both outside contamination and water loss under normal circumstances. Crucially, each cube is made individually by a dedicated jet spray to ensure the highest possible ice quality.



As the ice cube slowly forms the spray continues until the end of the cycle. No fresh water is required as the internal reservoir capacity is adequate for a full cycle of ice.



When the cube is fully formed the electronic controller initiates a hot gas defrost cycle. The water plate opens and the hot gas slowly warms the evaporator. At this point all remaining water from the ice making cycle is drained.



The ice will drop from the evaporator into the ice bin. The water plate will be rinsed with fresh water to remove any remaining particles before it starts to close again. Fresh water continues to enter until the reservoir is full to enable a new freeze cycle to commence.





IM-21CNE-HC

Production Capacity (kg/24h) Approx.	25
Storage Bin Capacity (kg) Approx.	11,5
Dimensions W x D x H (mm)	398 x 451 x 695
Electrical Supply	1/220 - 240V/50Hz
Electrical Capacity (kW)	0,22
Refrigerant	R290
Weight Gross / Net (kg)	34/39
Air Cooled Model(s)	IM-21CNE-HC
Type of Ice - Large Cube	IM-21CNE-HC
Optional	Legs for IM-21CNE



IM-30CNE-HC

Production Capacity (kg/24h) Approx.	30				
Storage Bin Capacity (kg) Approx.	11,5				
Dimensions W x D x H (mm)	398 x 451 x 695				
Electrical Supply	1/220 - 240V/50Hz				
Electrical Capacity (kW)	0,23				
Refrigerant	R290				
Weight Gross / Net (kg)	39/34				
Air Cooled Model(s)	IM-30CNE-HC, IM-30CNE-HC-25				
Type of Ice	<table border="1"> <tr> <td>Large Cube</td> <td>IM-30CNE-HC</td> </tr> <tr> <td>Small Cube</td> <td>IM-30CNE-HC-25</td> </tr> </table>	Large Cube	IM-30CNE-HC	Small Cube	IM-30CNE-HC-25
Large Cube	IM-30CNE-HC				
Small Cube	IM-30CNE-HC-25				



IM-45CNE-HC

Production Capacity (kg/24h) Approx.					
Storage Bin Capacity (kg) Approx.					
Dimensions W x D x H (mm)					
Electrical Supply					
Electrical Capacity (kW)					
Refrigerant					
Weight Gross / Net (kg)					
Air Cooled Model(s)					
Type of Ice	<table border="1"> <tr> <td>Large Cube</td> <td>IM-45CNE-HC</td> </tr> <tr> <td>Small Cube</td> <td>IM-45CNE-HC-25</td> </tr> </table>	Large Cube	IM-45CNE-HC	Small Cube	IM-45CNE-HC-25
Large Cube	IM-45CNE-HC				
Small Cube	IM-45CNE-HC-25				

COMING SOON

• Data shows the standard HC model • Production capacity (kg/24h): AT 10°C, WT 10°C.



Emerald Class Ice Makers - IM Hydrocarbon

www.hoshizaki-europe.com



IM-45NE-HC

Production Capacity (kg/24h) Approx.		
Storage Bin Capacity (kg) Approx.		
Dimensions W x D x H (mm)		
Electrical Supply		
Electrical Capacity (kW)		
Refrigerant		
Weight Gross / Net (kg)		
Air Cooled Model(s)		
Type of Ice	Large Cube	IM-45NE-HC
	Small Cube	IM-45NE-HC-25



IM-65NE-HC

Production Capacity (kg/24h) Approx.		
Storage Bin Capacity (kg) Approx.		
Dimensions W x D x H (mm)		
Electrical Supply		
Electrical Capacity (kW)		
Refrigerant		
Weight Gross / Net (kg)		
Air Cooled Model(s)		
Type of Ice	Large Cube	IM-65NE-HC
	Small Cube	IM-65NE-HC-25



IM-100NE-HC

Production Capacity (kg/24h) Approx.	105	
Storage Bin Capacity (kg) Approx.	50	
Dimensions W x D x H (mm)	704 x 506 x 1200 (Legs add 90-130mm)	
Electrical Supply	1/220 - 240V/50Hz	
Electrical Capacity (kW)	0,55	
Refrigerant	R290	
Weight Gross / Net (kg)	84/76	
Air Cooled Model(s)	IM-100NE-HC, IM-100NE-HC-23	
Type of Ice	Large Cube	IM-100NE-HC
	Medium Cube	IM-100NE-HC-23



• Data shows the standard HC model • Production capacity (kg/24h): AT 10°C, WT 10°C.

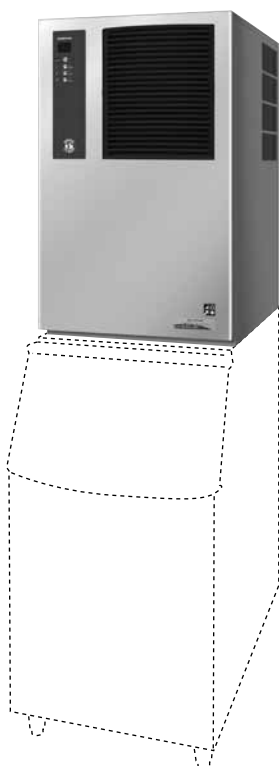

IM-130ANE-HC

Production Capacity (kg/24h) Approx.	125				
Dimensions W x D x H (mm) Approx.	560 x 700 x 880				
Electrical Supply	1/220 - 240V/50Hz				
Electrical Capacity (kW)	0.63				
Refrigerant	R290				
Weight Gross / Net (kg)	79/68				
Corresponding Bins	B-301SA, B-501SA, B-801SA				
Top Kits	See page 66 for Configurations				
Air Cooled Model(s)	IM-130ANE-HC, IM-130ANE-HC-23				
Type of Ice	<table border="1"> <tr> <td>Large Cube</td> <td>IM-130ANE-HC</td> </tr> <tr> <td>Medium Cube</td> <td>IM-130ANE-HC-23</td> </tr> </table>	Large Cube	IM-130ANE-HC	Medium Cube	IM-130ANE-HC-23
Large Cube	IM-130ANE-HC				
Medium Cube	IM-130ANE-HC-23				

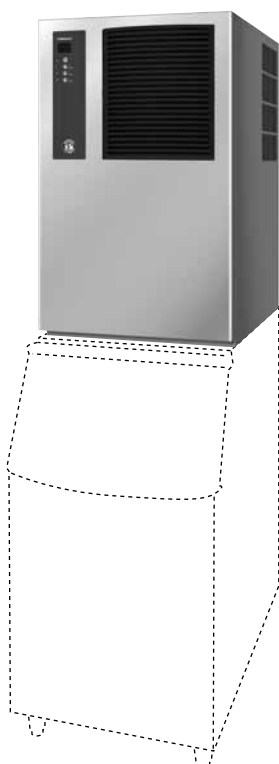

IM-240ANE-HC

Production Capacity (kg/24h) Approx.	235				
Dimensions W x D x H (mm) Approx.	560 x 700 x 880				
Electrical Supply	1/220 - 240V/50Hz				
Electrical Capacity (kW)	0.93				
Refrigerant	R290				
Weight Gross / Net (kg)	89/78				
Corresponding Bins	B-301SA, B-501SA, B-801SA				
Top Kits	See page 66 for Configurations				
Air Cooled Model(s)	IM-240ANE-HC, IM-240ANE-HC-23				
Type of Ice	<table border="1"> <tr> <td>Large Cube</td> <td>IM-240ANE-HC</td> </tr> <tr> <td>Medium Cube</td> <td>IM-240ANE-HC-23</td> </tr> </table>	Large Cube	IM-240ANE-HC	Medium Cube	IM-240ANE-HC-23
Large Cube	IM-240ANE-HC				
Medium Cube	IM-240ANE-HC-23				

• Data shows the standard HC model • Production capacity (kg/24h): AT 10°C, WT 10°C.



IM-21CNE

Production Capacity (kg/24h) Approx.	22
Storage Bin Capacity (kg) Approx.	11,5
Dimensions W x D x H (mm)	398 x 451 x 695
Electrical Supply	1/220 - 240V/50Hz
Electrical Capacity (kW)	0,24
Refrigerant	R134a
Weight Gross / Net (kg)	39/34
Air Cooled Model(s)	IM-21CNE
Type of Ice - Large Cube	IM-21CNE
Optional	Legs for IM-21CNE

Products available as 60hz models: IM-21CNE*



IM-30CNE

Production Capacity (kg/24h) Approx.	28	
Storage Bin Capacity (kg) Approx.	11,5	
Dimensions W x D x H (mm)	398 x 451 x 695 (Legs add 92-127mm)	
Electrical Supply	1/220 - 240V/50Hz	
Electrical Capacity (kW)	0,27	
Refrigerant	R134a	
Weight Gross / Net (kg)	39/34	
Air Cooled Model(s)	IM-30CNE, IM-30CNE-25	
Water Cooled Model(s)	IM-30CWNE, IM-30CWNE-25	
Type of Ice	Large Cube	IM-30CNE, IM-30CWNE
	Small Cube	IM-30CNE-25, IM-30CWNE-25

Products available as 60hz models: IM-30CNE*, IM-30CWNE*



IM-45CNE

Production Capacity (kg/24h) Approx.	44	
Storage Bin Capacity (kg) Approx.	15	
Dimensions W x D x H (mm)	633 x 511 x 690 (Legs add 90-125mm)	
Electrical Supply	1/220 - 240V/50Hz	
Electrical Capacity (kW)	0,32	
Refrigerant	R134a	
Weight Gross / Net (kg)	56/48	
Air Cooled Model(s)	IM-45CNE, IM-45CNE-25	
Type of Ice	Large Cube	IM-45CNE
	Small Cube	IM-45CNE-25

Products available as 60hz models: IM-45CNE*



*These products can be produced upon customer request. Please take longer lead times into consideration.

• Data shows the standard air cooled model • Production capacity (kg/24h): AT 10°C, WT 10°C.



IM Ice Makers - Self Contained

www.hoshizaki-europe.com



IM-45NE

Production Capacity (kg/24h) Approx.	44	
Storage Bin Capacity (kg) Approx.	18	
Dimensions W x D x H (mm)	503 x 456 x 840 (Legs add 90-125mm)	
Electrical Supply	1/220 - 240V/50Hz	
Electrical Capacity (kW)	0,33	
Refrigerant	R134a	
Weight Gross / Net (kg)	52/46	
Air Cooled Model(s)	IM-45NE, IM-45NE-25	
Water Cooled Model(s)	IM-45WNE, IM-45WNE-25	
Type of Ice	Large Cube	IM-45NE, IM-45WNE
	Small Cube	IM-45NE-25, IM-45WNE-25

Products available as 60hz models: IM-45NE*, IM-45NE-25*, IM-45WNE-25*, IM-45WNE*



IM-65NE

Production Capacity (kg/24h) Approx.	63	
Storage Bin Capacity (kg) Approx.	26	
Dimensions W x D x H (mm)	633 x 506 x 840 (Legs add 90-125mm)	
Electrical Supply	1/220 - 240V/50Hz	
Electrical Capacity (kW)	0,40	
Refrigerant	R134a	
Weight Gross / Net (kg)	61/53	
Air Cooled Model(s)	IM-65NE, IM-65NE-25	
Water Cooled Model(s)	IM-65WNE, IM-65WNE-25	
Type of Ice	Large Cube	IM-65NE, IM-65WNE
	Small Cube	IM-65NE-25

Products available as 60hz models: IM-65NE*, IM-65NE-25*, IM-65WNE*, IM-65WNE-25*



IM-100CNE

Production Capacity (kg/24h) Approx.	95	
Storage Bin Capacity (kg) Approx.	38	
Dimensions W x D x H (mm)	1004 x 600 x 800	
Electrical Supply	1/220 - 240V/50Hz	
Electrical Capacity (kW)	0,63	
Refrigerant	R134a	
Weight Gross / Net (kg)	88/77	
Air Cooled Model(s)	IM-100CNE, IM-100CNE-23, IM-100CNE-21*	
Type of Ice	Large Cube	IM-100CNE
	Medium Cube	IM-100CNE-23
	Extra Small Cube	IM-100CNE-21*

*These products can be produced upon customer request. Please take longer lead times into consideration.

• Data shows the standard air cooled model • Production capacity (kg/24h): AT 10°C, WT 10°C.



IM-100NE

Production Capacity (kg/24h) Approx.	95	
Storage Bin Capacity (kg) Approx.	50	
Dimensions W x D x H (mm)	704 x 506 x 1200 (Legs add 70-110mm)	
Electrical Supply	1/220 - 240V/50Hz	
Electrical Capacity (kW)	0,63	
Refrigerant	R134a	
Weight Gross / Net (kg)	85/76	
Air Cooled Model(s)	IM-100NE, IM-100NE-23, IM-100NE-21*	
Water Cooled Model(s)	IM-100WNE, IM-100WNE-23, IM-100WNE-21*	
Type of Ice	Large Cube	IM-100NE, IM-100WNE
	Medium Cube	IM-100NE-23, IM-100WNE-23
	Extra Small Cube	IM-100NE-21*, IM-100WNE-21*

Products available as 60hz models: IM-100NE*, IM-100NE-21*, IM-100NE-23*, IM-100WNE*, IM-100WNE-21*



IM-130NE

Production Capacity (kg/24h) Approx.	130	
Storage Bin Capacity (kg) Approx.	50	
Dimensions W x D x H (mm)	704 x 506 x 1200 (Legs add 70-110mm)	
Electrical Supply	1/220 - 240V/50Hz	
Electrical Capacity (kW)	0,70	
Refrigerant	R404A	
Weight Gross / Net (kg)	85/76	
Air Cooled Model(s)	IM-130NE, IM-130NE-23, IM-130NE-21*	
Water Cooled Model(s)	IM-130WNE, IM-130WNE-21, IM-130WNE-23	
Type of Ice	Large Cube	IM-130NE, IM-130WNE
	Medium Cube	IM-130NE-23, IM-130WNE-23
	Extra Small Cube	IM-130NE-21*, IM-130WNE-21



*These products can be produced upon customer request. Please take longer lead times into consideration.

• Data shows the standard air cooled model • Production capacity (kg/24h): AT 10°C, WT 10°C.



IM Ice Makers - Self Contained and Modular

www.hoshizaki-europe.com



IM-240NE

Production Capacity (kg/24h) Approx.	240	
Storage Bin Capacity (kg) Approx.	110	
Dimensions W x D x H (mm)	704 x 665 x 1510 (Legs add 70-110mm)	
Electrical Supply	1/220 - 240V/50Hz	
Electrical Capacity (kW)	1,32	
Refrigerant	R404A	
Weight Gross / Net (kg)	128/111	
Air Cooled Model(s)	IM-240NE, IM-240NE-23, IM-240NE-21*	
Water Cooled Model(s)	IM-240WNE, IM-240WNE-23	
Type of Ice	Large Cube	IM-240NE, IM-240WNE
	Medium Cube	IM-240NE-23, IM-240WNE-23
	Extra Small Cube	IM-240NE-21*

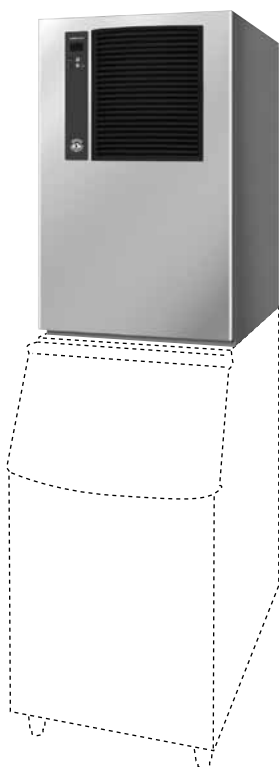

IM-240ANE

Production Capacity (kg/24h) Approx.	240	
Dimensions W x D x H (mm) Approx.	560 x 700 x 880	
Electrical Supply	1/220 - 240V/50Hz	
Electrical Capacity (kW)	1,32	
Refrigerant	R404A	
Weight Gross / Net (kg)	95/80	
Corresponding Bins	B-301SA, B-501SA, B-801SA	
Top Kits	See page 66 for Configurations	
Air Cooled Model(s)	IM-240ANE, IM-240ANE-23, IM-240ANE-21*	
Water Cooled Model(s)	IM-240AWNE	
Type of Ice	Large Cube	IM-240ANE, IM-240AWNE
	Medium Cube	IM-240AWNE-23
	Extra Small Cube	IM-240ANE-21*

Products available as 60hz models: IM-240ANE, IM-240AWNE*, IM-240AWNE-23*, IM-240AWNE-21*

*These products can be produced upon customer request. Please take longer lead times into consideration.

• Data shows the standard air cooled model • Production capacity (kg/24h): AT 10°C, WT 10°C.



IM-240D(W)NE / IM-240X(W)NE / IM-240DSNE* / IM-240XSNE* / IM-240A(W)NE

Production Capacity (kg/24h) Approx.	240/480/720**	
Dimensions W x D x H (mm)	1084 x 700 x 500	
Electrical Supply	1/220 - 240V/50Hz	
Electrical Capacity (kW)	1,33	
Refrigerant	R404A	
Weight Gross / Net (kg)	101/88	
Corresponding Bins	B-801SA, F650, 950/1025	
Top Kits	See page 66 for Configurations	
Air Cooled Model(s)	IM-240DNE, IM-240DNE-23, IM-240DNE-21* IM-240DNE-32*, IM-240XNE, IM-240XNE-23 IM-240XNE-21*, IM-240XNE-32*, IM-240ANE*	
Water Cooled Model(s)	IM-240DWNE, IM-240DWNE-23* IM-240DWNE-21*, IM-240DWNE-32* IM-240XWNE, IM-240XWNE-23*, IM-240XWNE-21*, IM-240XWNE-32* IM-240AWNE-23*, IM-240AWNE* IM-240AWNE-21*	
Air Cooled Model(s) With External Condenser	IM-240DSNE* , IM-240DSNE-23* IM-240XSNE* , IM-240XSNE-23*	
Type of Ice	Large Cube	IM-240DNE, IM-240XNE, IM-240DWNE, IM-240XWNE, IM-240DSNE* , IM-240XSNE* IM-240AWNE*
	Medium Cube	IM-240DNE-23, IM-240XNE-23, IM-240DWNE-23* ,IM-240XWNE-23* IM-240DSNE-23* , IM-240XSNE-23* IM-240AWNE-23*
	Extra Small Cube	IM-240DNE-21* , IM-240XNE-21* , IM-240DWNE-21* , IM-240XWNE-21* IM-240AWNE-21*
	Extra Large Cube	IM-240DNE-32* , IM-240XNE-32* IM-240DWNE-32* , IM-240XWNE-32*
Remote Condenser	URC-240CE	
Extension Machines	IM-240XNE, IM-240XNE-23, IM-240XNE-21* , IM-240XNE-32* , IM-240XWNE, IM-240XWNE-23* , IM-240XWNE-21* , IM-240XWNE-32* , IM-240XSNE* , IM-240XSNE-23*	

Products available as 60hz models: IM-240DNE*, IM-240DNE-21*, IM-240DNE-23*,
IM-240DWNE*, IM-240DWNE-21, IM-240DWNE-23*, IM-240XNE*, IM-240XNE-21*,
IM-240XNE-23*, IM-240XWNE*, IM-240XWNE-21*, IM-240XWNE-23*, IM-240ANE*,
IM-240AWNE-23*, IM-240AWNE*, IM-240AWNE-21*

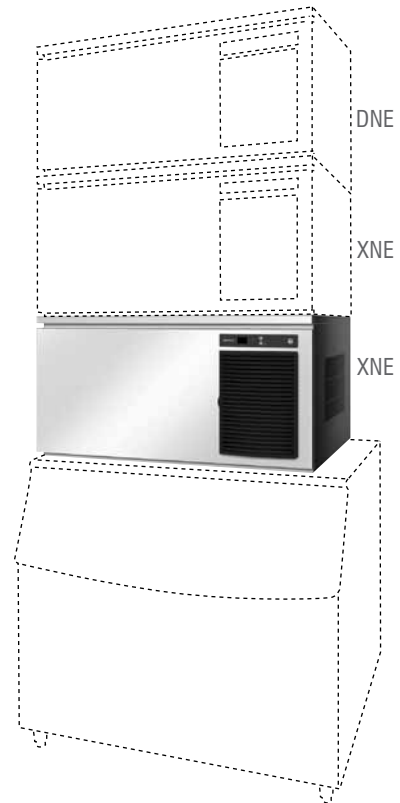

*These products can be produced upon customer request. Please take longer lead times into consideration.

**IM-240XNE extension machine for 480 kg (DNE+XNE) or 720 kg (DNE+2x XNE).

It is possible to stack the IM-240DNE on top of two IM-240XNE for a higher production capacity.

• Data shows the IM-240DNE • Production capacity (kg/24h): AT 10°C, WT 10°C.



IM Special - Self Contained

www.hoshizaki-europe.com



• Photo of IM-65NE-Q /LM/ LM103

IM-65NE-Q/LM*/LM103*

Production Capacity (kg/24h) Approx.	26(Q) /40(LM) /32(LM103)	
Storage Bin Capacity (kg) Approx.	17(Q) / 26(LM,LM103)	
Dimensions W x D x H (mm)	633 x 506 x 860 (Q,LM,LM103) (Legs add 90-125mm)	
Electrical Supply	1/220 - 240V/50Hz	
Electrical Capacity (kW)	0,39 (Q), 0,40 (LM,LM103)	
Refrigerant	R134a	
Weight Gross / Net (kg)	66(Q) 61/53	
Air Cooled Model(s)	IM-65NE-Q/LM*/LM103*	
Type of Ice	Ball Ice	IM-65NE-Q
	Big Cube XXL	IM-65NE-LM
	Long Cube XXXL	IM-65NE-LM103

Products available as 60hz models: IM-65NE-Q



• Photo of IM-65NE-H/S

IM-65NE-H*/S*

Production Capacity (kg/24h) Approx.	28(H) / 22(S)	
Storage Bin Capacity (kg) Approx.	26(H,S)	
Dimensions W x D x H (mm)	633 X 506 X 840 (H,S) (Legs add 90-125mm)	
Electrical Supply	1/220 - 240V/50Hz	
Electrical Capacity (kW)	0,40 (H,S)	
Refrigerant	R134a	
Weight Gross / Net (kg)	61/53	
Air Cooled Model(s)	IM-65NE-H*/S*	
Type of Ice	Heart Ice	IM-65NE-H
	Star Ice	IM-65NE-S



*These products can be produced upon customer request. Please take longer lead times into consideration.

• Data shows the standard air cooled model • Production capacity (kg/24h): AT 10°C, WT 10°C.



IM-65NE-C*

Production Capacity (kg/24h) Approx.	55
Storage Bin Capacity (kg) Approx.	26
Dimensions W x D x H (mm)	633 x 506 x 840 (Legs add 100-130mm)
Electrical Supply	1/220 - 240V/50Hz
Electrical Capacity (kW)	0,40
Refrigerant	R134a
Weight Gross / Net (kg)	61/53
Air Cooled Model(s)	IM-65NE-C*
Type of Ice	Cylinder Ice



IM-100NE-C*

Production Capacity (kg/24h) Approx.	85
Storage Bin Capacity (kg) Approx.	50
Dimensions W x D x H (mm)	704 x 506 x 1200 (Legs add 90-130mm)
Electrical Supply	1/220 - 240V/50Hz
Electrical Capacity (kW)	0.63
Refrigerant	R134a
Weight Gross / Net (kg)	85/76
Air Cooled Model(s)	IM-100NE-C*
Type of Ice	Cylinder Ice



*These products can be produced upon customer request. Please take longer lead times into consideration.

- Production capacity (kg/24h): AT 10°C, WT 10°C.



IM Cylinder - Modular

www.hoshizaki-europe.com

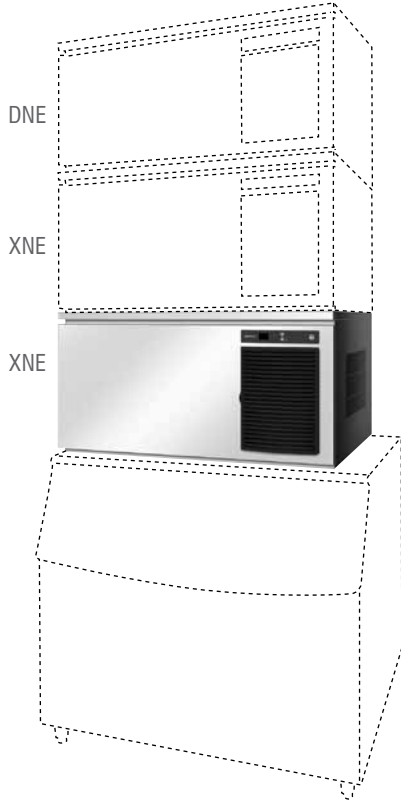

IM-240D(W)NE*/X(W)NE-C*

Production Capacity (kg/24h) Approx.	240/480/720**
Dimensions W x D x H (mm)	1084 x 700 x 500
Electrical Supply	1/220 - 240V/50Hz
Electrical Capacity (kW)	1,33
Refrigerant	R404A
Weight Gross / Net (kg)	101/89
Corresponding Bins	B-801SA, F650, 950/1025
Top Kits	See page 66 for Configurations
Air Cooled Model(s)	IM-240DNE-C*, IM-240XNE-C*
Water Cooled Model(s)	IM-240DWNE-C*, IM-240XWNE-C*
Type of Ice	Cylinder Ice
Extension Machines	IM-240XNE-C, IM-240XWNE-C

**IM-240XNE-C extension machine for 480 kg (DNE+XNE) or 720 kg (DNE+2x XNE). It is possible to stack the IM-240DNE-C on top of two IM-240XNE-C for a higher production capacity.

- Data shows the IM-240DNE-C

*These products can be produced upon customer request. Please take longer lead times into consideration.

- Production capacity (kg/24h): AT 10°C, WT 10°C.



FM Range



Please visit our website to view our trading terms and conditions.



FM Product Highlights

The FM Range produces Flake or Nugget ice. It uses the most efficient ice making process due to the unique auger system.



Flake and Nugget ice are popular for a variety of cooling purposes.

Flake ice applications include:

- Food processing.
- Fish and fresh produce display.
- Organ transportation in medical arena.

The main characteristic of Hoshizaki's Flake ice is that 'freeze- burn' is prevented when displaying fresh fish or produce.

Nugget ice applications include:

- Display of packaged produce such as bottled beverages and food.
- Key ingredient in cocktails.

Hoshizaki's Nugget ice is compressed by the extruding head, producing harder, dry ice.



Hoshizaki ice makers in this range can be converted to either flake or nugget ice, providing a higher level of flexibility than other machines on the market.

Due to the auger system the water consumption is equal to the ice production.

	Ice	Water
Flake Ice	70%	30%
Nugget Ice	88%	12%
Cubelet Ice*	90%	10%

*Cubelet ice is produced by the CM140KE (page 40).



FM Ice Production

- FM's condenser utilises carbon auger bearings, which are more reliable than roller bearings as used by other manufacturers. Carbon auger bearings do not require oil or grease like roller bearings do, eliminating risk of oil leakage.
- The auger is of double hardened steel. The auger in combination with the carbon bearings, work optimally in a tough and wet environment. Benefits include: longer product life expectancy and reduced maintenance costs.
- The FM uses the most efficient ice making process due to Hoshizaki's unique FM auger system. It utilises all water brought into the machine; therefore water consumption is equal to ice production.

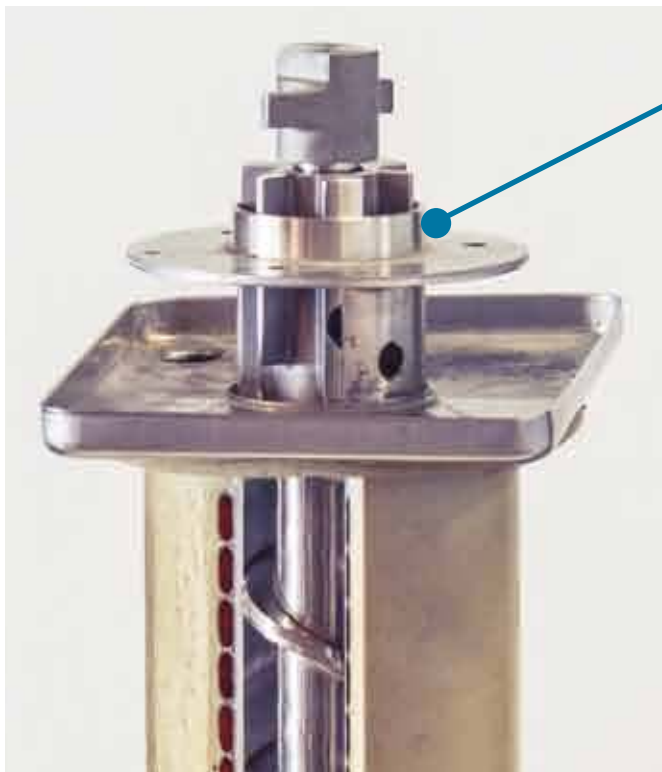



FM-170EE-HC/HCN



Production Capacity (kg/24h) Approx.	165 (F) / 145 (N)	
Storage Bin Capacity (kg) Approx.	26(F) / 32(N)	
Dimensions W x D x H (mm)	640 x 600 x 800	
Electrical Supply	1/220 - 240V/50Hz	
Electrical Capacity (kW)	0,495(F) / 0,500(N)	
Refrigerant	R290	
Weight Gross / Net (kg)	82/71	
Air Cooled Model(s)	FM-170EE-HC, FM-170EE-HCN	
Type of Ice	Flake Ice	FM-170EE-HC
	Nugget Ice	FM-170EE-HCN



FM-170EE-50-HC/HCN

• Photo of FM-170EE-50-HC/HCN

Production Capacity (kg/24h) Approx.	165 (F) / 145 (N)	
Storage Bin Capacity (kg) Approx.	57(F) / 65(N)	
Dimensions W x D x H (mm)	940 x 600 x 800	
Electrical Supply	1/220 - 240V/50Hz	
Electrical Capacity (kW)	0,495(F) / 0,500(N)	
Refrigerant	R290	
Weight Gross / Net (kg)	94/81	
Air Cooled Model(s)	FM-170EE-50-HC, FM-170EE-50-HCN	
Type of Ice	Flake Ice	FM-170EE-50-HC
	Nugget Ice	FM-170EE-50-HCN

• Production capacity (kg/24h): AT 10°C, WT 10°C.

FM-300AKE-HC/HCN-SB

Production Capacity (kg/24h) Approx.	300 (F) / 250 (N)	
Dimensions W x D x H (mm)	560 x 700 x 780	
Electrical Supply	1/220 - 240V/50Hz	
Electrical Capacity (kW)	0,9(F) / 0.96(N)	
Refrigerant	R290	
Weight Gross / Net (kg)	88/81	
Corresponding Bins	B-301SA, B-501SA, B-801SA	
Air Cooled Model(s)	FM-300AKE-HC-SB, FM-300AKE-HCN-SB	
Type of Ice	Flake Ice	FM-300AKE-HC-SB
	Nugget Ice	FM-300AKE-HCN-SB

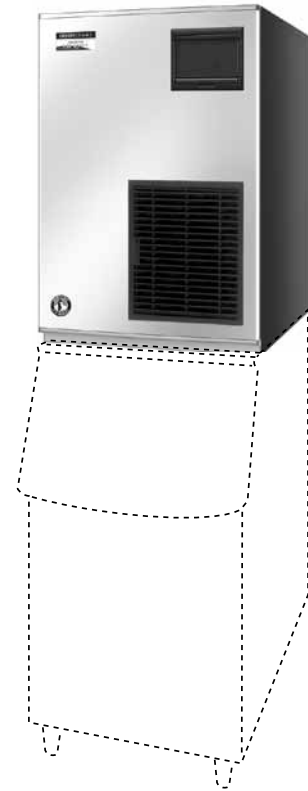

FM-480AKE-HC/HCN-SB

Production Capacity (kg/24h) Approx.	450 (F) / 380 (N)	
Dimensions W x D x H (mm)	560 x 700 x 780	
Electrical Supply	1/220 - 240V/50Hz	
Electrical Capacity (kW)	1,10(F) / 1.17(N)	
Refrigerant	R290	
Weight Gross / Net (kg)	99/92	
Corresponding Bins	B-301SA, B-501SA, B-801SA	
Air Cooled Model(s)	FM-480AKE-HC-SB, FM-480AKE-HCN-SB	
Type of Ice	Flake Ice	FM-480AKE-HC-SB
	Nugget Ice	FM-480AKE-HCN-SB

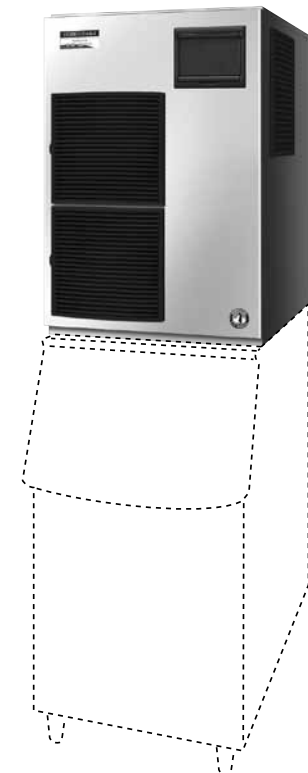

- Production capacity (kg/24h): AT 10°C, WT 10°C.



FM Ice Makers - Self Contained

www.hoshizaki-europe.com



FM-80KE/-N

Production Capacity (kg/24h) Approx.	85(F) / 65(N)	
Storage Bin Capacity (kg) Approx.	26(F) / 32(N)	
Dimensions W x D x H (mm)	640 x 600 x 800	
Electrical Supply	1/220 - 240V/50Hz	
Electrical Capacity (kW)	0,3	
Refrigerant	R134a	
Weight Gross / Net (kg)	75/65	
Air Cooled Model(s)	FM-80KE, FM-80KE-N	
Type of Ice	Flake Ice	FM-80KE
	Nugget Ice	FM-80KE-N



FM-150KE/-N, CM-140KE

Production Capacity (kg/24h) Approx.	150(F) / 140(N) / 140(C)	
Storage Bin Capacity (kg) Approx.	26(F) / 32(N) / 32(C)	
Dimensions W x D x H (mm)	640 x 600 x 800	
Electrical Supply	1/220 - 240V/50Hz	
Electrical Capacity (kW)	0,64	
Refrigerant	R134a	
Weight Gross / Net (kg)	82/71	
Air Cooled Model(s)	FM-150KE, FM-150KE-N, CM-140KE	
Type of Ice	Flake Ice	FM-150KE
	Nugget Ice	FM-150KE-N
	Cubelet Ice	CM-140KE



FM-150KE-50/-N

Production Capacity (kg/24h) Approx.	150(F) / 140(N)	
Storage Bin Capacity (kg) Approx.	57(F) / 65(N)	
Dimensions W x D x H (mm)	940 x 600 x 800	
Electrical Supply	1/220 - 240V/50Hz	
Electrical Capacity (kW)	0,64	
Refrigerant	R134a	
Weight Gross / Net (kg)	94/81	
Air Cooled Model(s)	FM-150KE-50, FM-150KE-50-N	
Type of Ice	Flake Ice	FM-150KE-50
	Nugget Ice	FM-150KE-50-N

• Data shows the standard air cooled flake and nugget model • Production capacity (kg/24h): AT 10°C, WT 10°C.



FM-170AKE/-N-SB

Production Capacity (kg/24h) Approx.	170(F) / 160(N)	
Dimensions W x D x H (mm)	560 x 700 x 780	
Electrical Supply	1/220 - 240V/50Hz	
Electrical Capacity (kW)	0,60(F) / 0,62(N)	
Refrigerant	R134a	
Weight Gross / Net (kg)	75/68	
Corresponding Bins	B-301SA, B-501SA, B-801SA	
Top Kits	See page 66 for Configurations	
Air Cooled Model(s)	FM-170AKE-SB, FM-170AKE-N-SB	
Type of Ice	Flake Ice	FM-170AKE-SB
	Nugget Ice	FM-170AKE-N-SB

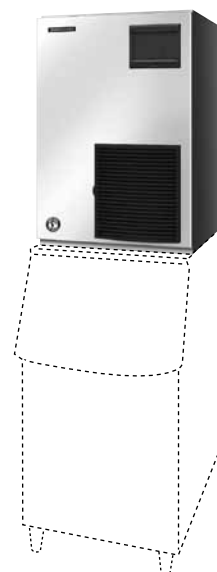

FM-300AKE/-N-SB

Production Capacity (kg/24h) Approx.	320(F) / 270(N)	
Dimensions W x D x H (mm)	560 x 700 x 780	
Electrical Supply	1/220 - 240V/50Hz	
Electrical Capacity (kW)	1,0	
Refrigerant	R404A	
Weight Gross / Net (kg)	87/80	
Corresponding Bins	B-301SA, B-501SA, B-801SA	
Top Kits	See page 66 for Configurations	
Air Cooled Model(s)	FM-300AKE-SB, FM-300AKE-N-SB	
Type of Ice	Flake Ice	FM-300AKE-SB
	Nugget Ice	FM-300AKE-N-SB

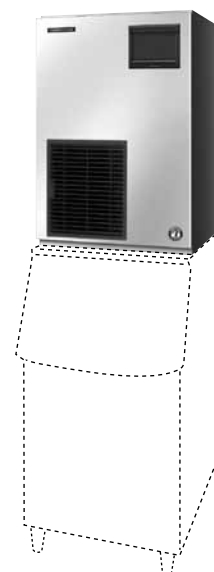

Products available as 60hz models: FM-300AKE-SB*, FM-300AKE-N-SB*

*These products can be produced upon customer request. Please take longer lead times into consideration.

- Production capacity (kg/24h): AT 10°C, WT 10°C.



FM Ice Makers - Modular

www.hoshizaki-europe.com

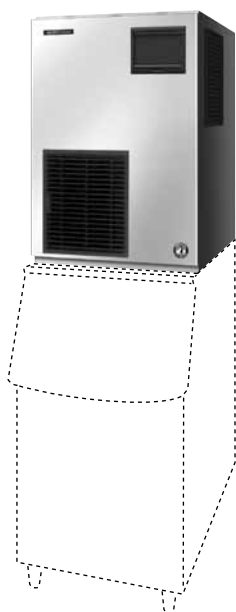

FM-480AKE/-N-SB

Production Capacity (kg/24h) Approx.	500(F) / 430(N)	
Dimensions W x D x H (mm)	560 x 700 x 780	
Electrical Supply	1/230V/50Hz	
Electrical Capacity (kW)	1,65	
Refrigerant	R404A	
Weight Gross / Net (kg)	102/95	
Corresponding Bins	B-301SA, B-501SA, B-801SA	
Top Kits	See page 66 for Configurations	
Air Cooled Model(s)	FM-480AKE-SB, FM-480AKE-N-SB	
Water Cooled Model(s)	FM-480AWKE-SB, FM-480AWKE-N-SB	
Air cooled Remote Model(s)	FM-481ALGE-SB*, FM-481ALGE-N-SB*	
Type of Ice	Flake Ice	FM-480AKE-SB, FM-480AWKE-SB, FM-481ALGE-SB*
	Nugget Ice	FM-480AKE-N-SB, FM-480AWKE-N-SB, FM-481ALGE-N-SB*

Products available as 60hz models: FM-480AKE-SB*, FM-480AKE-N-SB*

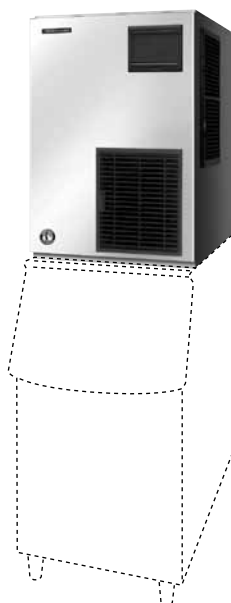

FM-600AKE/-N-SB

Production Capacity (kg/24h) Approx.	600(F) / 530(N)	
Dimensions W x D x H (mm)	560 x 700 x 780	
Electrical Supply	1/220 - 240V/50Hz	
Electrical Capacity (kW)	1,90(F) / 1,95(N)	
Refrigerant	R404A	
Weight Gross / Net (kg)	114/107	
Corresponding Bins	B-301SA, B-501SA, B-801SA	
Top Kits	See page 66 for Configurations	
Air Cooled Model(s)	FM-600AKE-SB, FM-600AKE-N-SB	
Water Cooled Model(s)	FM-600AWKE-SB*, FM-600AWKE-N-SB*	
Type of Ice	Flake Ice	FM-600AKE-SB, FM-600AWKE-SB*
	Nugget Ice	FM-600AKE-N-SB, FM-600AWKE-N-SB*

Products available as 60hz models: FM-600AKE-SB*, FM-600AKE-N-SB*

*These products can be produced upon customer request. Please take longer lead times into consideration.

- Production capacity (kg/24h): AT 10°C, WT 10°C.



FM-750AKE/-N

Production Capacity (kg/24h) Approx.	750(F) / 590(N)	
Dimensions W x D x H (mm)	762 x 700 x 780	
Electrical Supply	1/220 - 240V/50Hz	
Electrical Capacity (kW)	1,88(F) / 2,01(N)	
Refrigerant	R404A	
Weight Gross / Net (kg)	143/133	
Corresponding Bins	B-501SA, B-801SA	
Top Kits	See page 66 for Configurations	
Air Cooled Model(s)	FM-750AKE, FM-750AKE-N	
Type of Ice	Flake Ice	FM-750AKE
	Nugget Ice	FM-750AKE-N

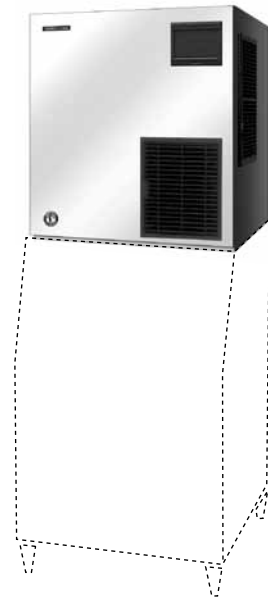

FM-1000AKE/-N

Production Capacity (kg/24h) Approx.	1030(F) / 860(N)	
Dimensions W x D x H (mm)	762 x 700 x 780	
Electrical Supply	1/220 - 240V/50Hz	
Electrical Capacity (kW)	2,49(F) / 2,55(N)	
Refrigerant	R404A	
Weight Gross / Net (kg)	156/146	
Corresponding Bins	B-501SA, B-801SA	
Top Kits	See page 66 for Configurations	
Air Cooled Model(s)	FM-1000AKE, FM-1000AKE-N	
Type of Ice	Flake Ice	FM-1000AKE
	Nugget Ice	FM-1000AKE-N

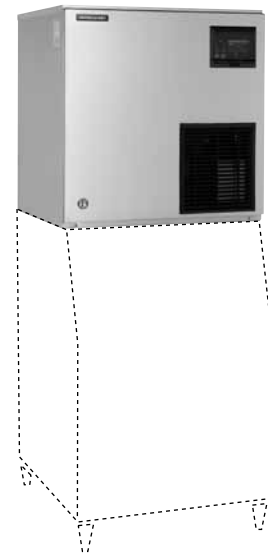

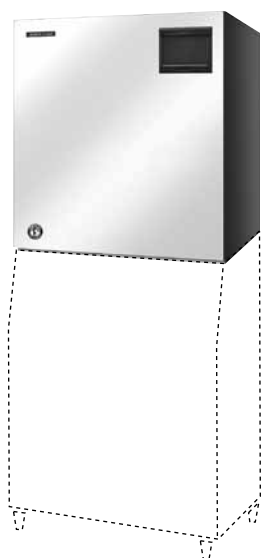

FM-1200ALKE/-N

Production Capacity (kg/24h) Approx.	1200(F) / 1060(N)	
Dimensions W x D x H (mm)	762 x 700 x 780	
Electrical Supply	1/220 - 240V/50Hz	
Electrical Capacity (kW)	0,47(F) / 0,515(N)	
Refrigerant	R404A	
Weight Gross / Net (kg)	108/98	
Excluding the Remote Refrigeration Unit	2,83kW / -25°C	
Corresponding Bins	B-501SA, B-801SA	
Top Kits	See page 66 for Configurations	
Air Cooled Model(s) Without Refrigeration Unit	FM-1200ALKE, FM-1200ALKE-N	
Type of Ice	Flake Ice	FM-1200ALKE
	Nugget Ice	FM-1200ALKE-N

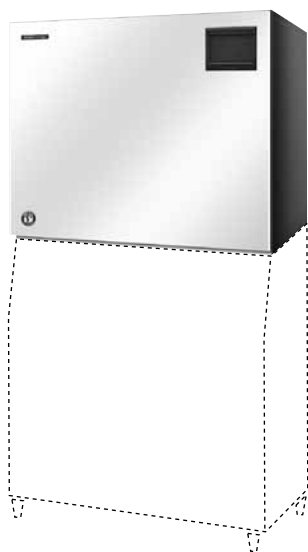

FM-1800ALKE/-N

Production Capacity (kg/24h) Approx.	1800(F) / 1590(N)	
Dimensions W x D x H (mm)	1080 x 700 x 780	
Electrical Supply	1/220 - 240V/50Hz	
Electrical Capacity (kW)	0,71(F) / 0,77(N)	
Refrigerant	R404A	
Weight Gross / Net (kg)	155/140	
Excluding the Remote Refrigeration Unit	4,3kW / -25°C	
Corresponding Bins	B-801SA	
Top Kits	See page 66 for Configurations	
Air Cooled Model(s) Without Refrigeration Unit	FM-1800ALKE, FM-1800ALKE-N	
Type of Ice	Flake Ice	FM-1800ALKE
	Nugget Ice	FM-1800ALKE-N

• Production capacity (kg/24h): AT 10°C, WT 10°C.



KM Range



Please visit our website to view our trading terms and conditions.



KM Product Highlights

- KM machines produce clear, crescent shaped ice. The unique shape is built from the inside out with an internal temperature of -4°C .
- Cubes produced are crystal clear as only the purest water molecules will freeze on Hoshizaki's US patented evaporator.
- Due to the half-moon shape and the consistent cube size, maximum storage bin capacity is optimised.



- An easily cleanable air filter allows users to carry out routine cleaning themselves, extending machine life and cutting the frequency and cost of maintenance call-outs.

Extremely versatile ice. Extends from the splash-free serving of post mix soft drinks through to diverse applications such as fish transportation, bottle and fish display and even laser therapy. Suitable for fast selling establishments such as nightclubs, sporting and entertainment events.





- Hoshizaki's stainless steel evaporator design has eliminated plating and ice bridging for unmatched reliability (US patented).
- Double-sided ice making surface. This requires fewer cycles to produce a full bin of ice, thereby reducing energy consumption.
- Greatly reduces mineral build-up helping to produce clear, hard crescent cubes. Also improves pump and compressor operation.
- Poor water quality is one of the major causes of equipment breakdown. The double flushing system offers built-in self-cleaning, improving machine life.



CycleSaver® design allows KM machines to produce the same quantity of ice in about half as many cycles as competitive ice makers. Fewer cycles add up to longer life and less maintenance than competitive units. Hoshizaki KM's will produce more ice, using less energy, while cycling 1/2 as many times as the competition.

Benefits:

- Reducing operating cycles by half in 24 hours, while producing the same quantity of ice vs competitors.
- Reduces energy consumption.
- Reduces mandatory cleaning and maintenance.
- Increases machine life and customer profits.



EverCheck™ Control Board with audible alarm and diagnostic features, designed to assist service technicians in diagnosing problems. The majority of all service and maintenance can be accomplished from the front of unit. These controls are also located in a dry environment, greatly improving electrical component reliability.

Benefits:

- Consistent ice formation under all ambient conditions.
- Protection from water loss, or filter restriction.
- Eliminates mechanical moving parts: less down time, fewer repairs, longer life.



KM Ice Makers - Self Contained

www.hoshizaki-europe.com



KM-35A

Production Capacity (kg/24h) Approx.	36
Storage Bin Capacity (kg) Approx.	16
Dimensions W x D x H (mm)	452 x 617 x 842
Electrical Supply	1/220 - 240V/50Hz
Electrical Capacity (kW)	0,195
Refrigerant	R134a
Weight Gross / Net (kg)	49/39
Air Cooled Model(s)	KM-35A
Type of Ice	Crescent
Optional	Instruction manual, scoop, adjustable bolt, outlet hose



KM-50A

Production Capacity (kg/24h) Approx.	52
Storage Bin Capacity (kg) Approx.	23
Dimensions W x D x H (mm)	605 x 617 x 842
Electrical Supply	1/220 - 240V/50Hz
Electrical Capacity (kW)	0,303
Refrigerant	R134a
Weight Gross / Net (kg)	58/46
Air Cooled Model(s)	KM-50A
Type of Ice	Crescent
Optional	Instruction manual, scoop, adjustable bolt, outlet hose



KM-75A

Production Capacity (kg/24h) Approx.	72
Storage Bin Capacity (kg) Approx.	40
Dimensions W x D x H (mm)	605 x 719 x 842
Electrical Supply	1/220 - 240V/50Hz
Electrical Capacity (kW)	0,412
Refrigerant	R134a
Weight Gross / Net (kg)	64/51
Air Cooled Model(s)	KM-75A
Type of Ice	Crescent
Optional	Instruction manual, scoop, adjustable bolt, outlet hose

- Production capacity (kg/24h): AT10°C, WT10°C.



KM-100A

Production Capacity (kg/24h) Approx.	101
Storage Bin Capacity (kg) Approx.	45
Dimensions W x D x H (mm)	612 x 712 x 992
Electrical Supply	1/220 - 240V/50Hz
Electrical Capacity (kW)	0,584
Refrigerant	R404A
Weight Gross / Net (kg)	82/62
Air Cooled Model(s)	KM-100A
Type of Ice	Crescent



KM-125A

Production Capacity (kg/24h) Approx.	128
Storage Bin Capacity (kg) Approx.	55
Dimensions W x D x H (mm)	762 x 712 x 992
Electrical Supply	1/220 - 240V/50Hz
Electrical Capacity (kW)	0,774
Refrigerant	R404A
Weight Gross / Net (kg)	92/70
Air Cooled Model(s)	KM-125A
Type of Ice	Crescent



KM-320MAH-E / KM-515MAH-E

Production Capacity (kg/24h) Approx.	157 / 264
Dimensions W x D x H (mm)	560 x 695 x 770
Electrical Supply	1/220 - 240V/50Hz
Electrical Capacity (kW)	0,71 / 1,2
Refrigerant	R404A
Weight Gross / Net (kg)	79/69, 79/68
Air Cooled Model(s)	KM-320MAH-E, KM-515MAH-E
Type of Ice	Crescent
Corresponding Bins	B-301SA, B-501SA, B-801SA

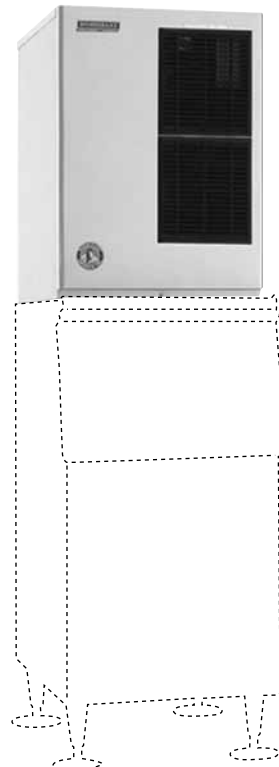

• Production capacity (kg/24h): AT10°C, WT10°C.

• Photo of KM-515MAH-E



KM Ice Makers - Modular

www.hoshizaki-europe.com

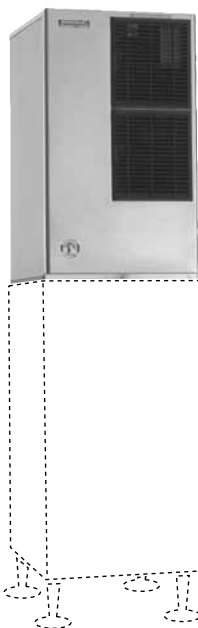

KM-650MAH-E

Production Capacity (kg/24h) Approx.	333
Dimensions W x D x H (mm)	560 x 695 x 950
Electrical Supply	1/220 - 240V/50Hz
Electrical Capacity (kW)	1,2
Refrigerant	R404A
Weight Gross / Net (kg)	91/77
Air Cooled Model(s)	KM-650MAH-E
Type of Ice	Crescent
Corresponding Bins	B-301SA, B-501SA, B-801SA

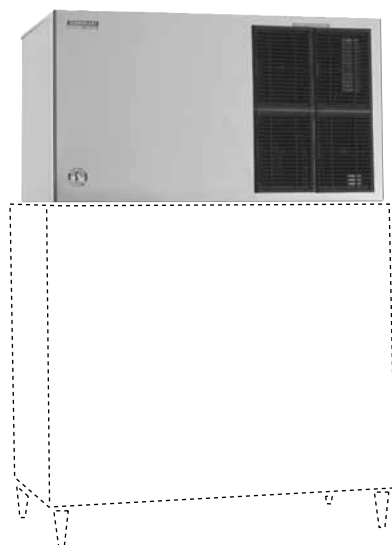

KM-1301SAH-E

Production Capacity (kg/24h) Approx.	584
Dimensions W x D x H (mm)	1219 x 695 x 695
Electrical Supply	1/220 - 240V/50Hz
Electrical Capacity (kW)	2,12
Refrigerant	R404A
Weight Gross / Net (kg)	143/125
Corresponding Bins	B-801SA
Air cooled model(s)	KM-1301SAH-E
Water Cooled Model(s)	KM-1301SWH-E*
Type of Ice	Crescent
Remote Condenser Unit	KM-1301SRH-E*
Remote Condenser	URC14FE
Remote Condenser Connection Set	OS Quick

KM-1301 can be stacked 2 high for 1168kg production

*These products can be produced upon customer request. Please take longer lead times into consideration.
• Data shows the standard air cooled model • Production capacity (kg/24h): AT10°C, WT10°C.



KMD-201AA

Production Capacity (kg/24h) Approx.	190
Dimensions W x D x H (mm)	560 x 625 x 610
Electrical Supply	1/220 - 240V/50Hz
Electrical Capacity (kW)	0,7
Refrigerant	R404A
Weight Gross / Net (kg)	73/57
Corresponding Bins	B-301SA, B-501SA, B-801SA and Lancer dispensers
Air cooled Model(s)	KMD-201AA
Water Cooled Model(s)	KMD-201AWA
Type of Ice	Crescent

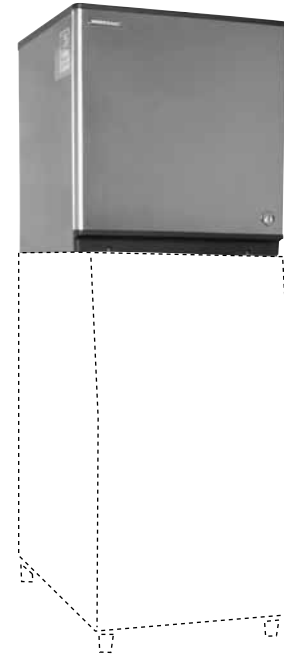

KMD-201AA on top of Lancer dispenser IBD4400



KMD-270AA

Production Capacity (kg/24h) Approx.	265
Dimensions W x D x H (mm)	560 x 625 x 610
Electrical Supply	1/220 - 240V/50Hz
Electrical Capacity (kW)	1,03
Refrigerant	R404A
Weight Gross / Net (kg)	73/57
Corresponding Bins	B-301SA, B-501SA, B-801SA and Lancer dispensers
Air cooled Model(s)	KMD-270AA
Water Cooled Model(s)	KMD-270AWA
Type of Ice	Crescent

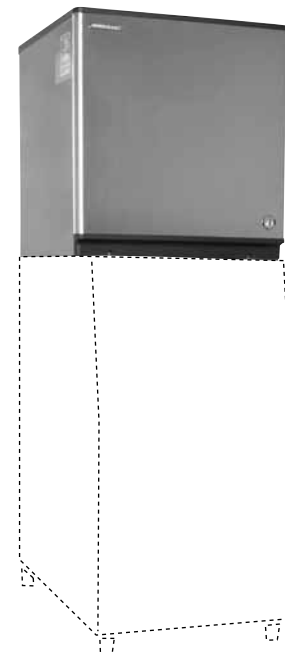

• Data shows the standard air cooled model • Production capacity (kg/24h): AT10°C, WT10°C.



NEW

AM COMPACT



Small in a Big Way

Undercounter model, suitable for small applications.

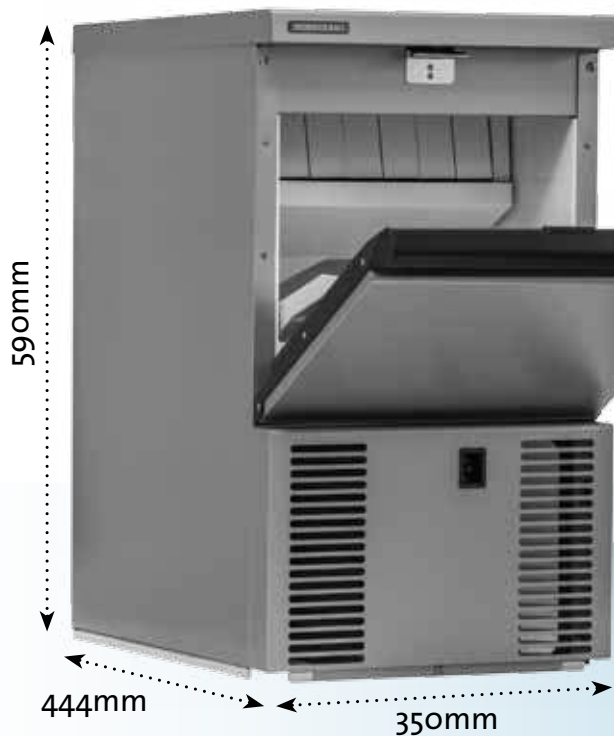

Cleaning Made Easy

- Efficient evaporator is easy to clean
- Front accessible parts with removable water tank
- Fewer moving parts for longer life
- Easily disassembled water circuit for easy cleaning





AM Ice Makers - Self Contained

www.hoshizaki-europe.com



AM-20CAE

Production Capacity (kg/24h) Approx.	28
Storage Bin Capacity (kg) Approx.	4
Dimensions W x D x H (mm)	350 x 444 x 590
Electrical Supply	1/220 - 240V/50Hz
Electrical Capacity (kW)	0.23
Refrigerant	R134a
Weight Gross / Net (kg)	34/28
Air Cooled Model(s)	AM-20CAE
Type of Ice	Top Hat Ice



COMPACT design fits under any counter



Easy, convenient and inexpensive installation



Durable exterior, fingerprint resistant



Ice Production approx. 28kg per 24 hours



Auto shut off when ice bin is full



Eco-Friendly water based Polyurethane foam



Front venting for built-in or free standing installation



Front power switch with adjustable thermostat



Made in E.U.



Individual jet system for more consistent ice production



Ø 20 mm / 27 mm (h)



HACCP Certified



• Production capacity (kg/24h): AT10°C, WT10°C.



Ice and/or Water Dispensers

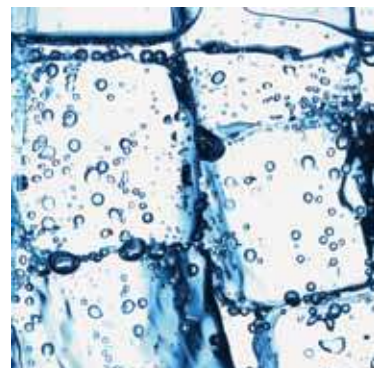



Product Highlights



The DCM Range of ice/water dispensers produce the following combinations: cubelet ice, cubelet ice and water or dispense only water. These systems can be used for multiple environments including food and beverage, leisure and healthcare.

- Portion control can be easily set, making it easy to regulate the consumption of ice among end-users, reducing energy consumption and waste.
- Hoshizaki ice dispensers are more compact with reduced space requirements and in line with modern interiors.
- Ice dispensing system includes lever and LED operation buttons, easy and simple to use, therefore ideal for self-serving environment.
- New lever design prevents touching the lip of a glass, minimising risk of bacterial transfer.
- The DCM uses the most efficient ice making process due to its auger system. It utilises all water brought into the machine; therefore water consumption is equal to ice production.



	Ice	Water
Cubelet Ice	90%	10%



The DCM-6oKE





DCM-60KE (-P)

Production Capacity (kg/24h) Approx.	60
Storage Bin Capacity (kg) Approx.	1,9
Dimensions W x D x H (mm)	350 x 585 x 695 (max 710)
Electrical Supply	1/220 - 240V/50Hz
Electrical Capacity (kW)	0,28
Refrigerant	R134a
Weight Gross / Net (kg)	56/47
Type of Ice	Cubelet + Water
Available With	Lever/Push button (-P)
Optional	Push button on request (-P)

Product also available as 60hz model*



DCM-120KE (-P)

Production Capacity (kg/24h) Approx.	125
Storage Bin Capacity (kg) Approx.	4
Dimensions W x D x H (mm)	350 x 585 x 815 (max 830)
Electrical Supply	1/220 - 240V/50Hz
Electrical Capacity (kW)	0,48
Refrigerant	R134a
Weight Gross / Net (kg)	66/57
Type of Ice	Cubelet + Water
Available With	Lever/Push button (-P)
Optional	Push button on request (-P)

Product also available as 60hz model*



DCM-230HE

Production Capacity (kg/24h) Approx.	230
Storage Bin Capacity (kg) Approx.	18
Dimensions W x D x H (mm)	660 x 571 x 1016
Electrical Supply	1/230V/50Hz
Electrical Capacity (kW)	0,815
Refrigerant	R404A
Weight Gross / Net (kg)	120/108
Type of Ice	Cubelet + Water



*These products can be produced upon customer request. Please take longer lead times into consideration.

- Production capacity (kg/24h): AT 10°C, WT 10°C.



Product Highlights



The DIM-30DE-1 produces cubed ice and has a new exterior design. The freshly produced ice does not come in contact with light or air when stored and therefore maintains the highest quality. Its ice is very well suited for multiple environments including food and beverage, leisure and healthcare.



DIM-30DE-1

Production Capacity (kg/24h) Approx.	32
Storage Bin Capacity (kg) Approx.	15
Dimensions W x D x H (mm)	350 x 526 x 1590
Electrical Supply	1/220 - 240V 50/60Hz
Electrical Capacity (kW)	0,32 / 0,33
Refrigerant	R134a
Weight Gross / Net (kg)	71/65
Type of Ice	Cube ice

Product also available as 60hz model*

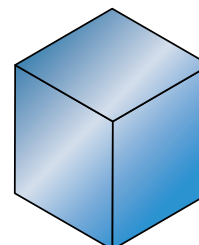

Ice Type: Cube
Size: 28 x 28 x 32 mm

*These products can be produced upon customer request. Please take longer lead times into consideration.
• Production capacity (kg/24h): AT 10°C, WT 10°C.

Product Highlights



The DSM-12CE is an ice dispenser that produces Shuttle ice. It is the most compact dispenser in our range and can be used for multiple environments including food and beverage, leisure and health care.

- Portion control can be easily set, making it easy to regulate the consumption of ice among end-users, reducing energy consumption and waste.
- Hoshizaki ice dispensers are more compact with reduced space requirements and in line with modern interiors.
- Due to the auger system the water consumption is equal to the ice production.



DSM-12CE

Production Capacity (kg/24h) Approx.	13
Storage Bin Capacity (kg) Approx.	3
Dimensions W x D x H (mm)	180 x 510 x 695
Electrical Supply	1/220 - 240V/50Hz
Electrical Capacity (kW)	0,26
Refrigerant	R134a
Weight Gross / Net (kg)	26/23
Type of Ice	Shuttle



Shuttle - 3g

- Production capacity (kg/24h): AT10°C, WT10°C.





Bins, Transport Systems and Crushers





Storage Bins



The B-301SA, B-501SA and B-801SA Storage Bins are configured perfectly with Hoshizaki ice makers to ensure ample quantities of ice at all times.

- Foamed in place insulation, ensures low melt rate ice storage.
- The stainless steel exterior provides long lasting attractive appearance.
- Easy to clean with round edges for optimal hygiene.
- Manufactured with adjustable legs from 90mm to 120mm.
- Sturdy construction for side by side/stacked installation and non-corrosive bin liner provide safe and sanitary storage of Cube and Flake ice.



B-801SA



B-301SA

Bin Capacity (kg) Approx.	144
Dimensions W x D x H (mm)	560 x 820 x 1016 (Excluding legs)
Weight Gross / Net (kg)	49/37



B-501SA

Bin Capacity (kg) Approx.	217
Dimensions W x D x H (mm)	762 x 820 x 1016 (Excluding legs)
Weight Gross / Net (kg)	57/47



B-801SA

Bin Capacity (kg) Approx.	348
Dimensions W x D x H (mm)	1220 x 820 x 1016 (Excluding legs)
Weight Gross / Net (kg)	86/64
Optional	Bin dividers on request



OTHER BRANDED BINS

Model	Bin Capacity (kg) Approx.	Dimensions (Including legs) W x D x H (mm)	Weight (kg)
E-600-42S	258	1087 x 686 x 1019	70
E-650-44S	299	1118 x 749 x 1016	84
E-950-48S	431	1219 x 718 x 1270	110
E-1025-52S	467	1321 x 718 x 1270	111



Top Kits

Some ice maker bin combinations may require a top kit. Please check the following table for possible configurations.

If you wish to combine one of our ice makers with other branded bins, please consult us as other top kits may apply.

TOP KITS

TK 4 DM	TK 18 D
TK 4 DR	TK IMD2
TK 8 D	TK 1800

TOP KIT CONFIGURATIONS

Quantity	Ice Maker Model	B-301SA	B-501SA	B-801SA
	IM-240D	n.a.	n.a.	TK IMD2
	IM-240A	–	TK 8 D	TK 8 D + TK 18 D
	KM-320/515/650	n.a.	TK 8 D	TK 8 D + TK 18 D
2x	KM-320/515/650	n.a.	n.a.	TK 4 DM
	KM-1301	n.a.	n.a.	–
	KMD-201	–	TK 8 D	TK 8 D + TK 18 D
	KMD-270	–	TK 8 D	TK 8 D + TK 18 D
	FM-170	–	TK 8 D	TK 8 D + TK 18 D
	FM-300/-HC	–	TK 8 D	TK 8 D + TK 18 D
	FM-480/-HC	–	TK 8 D	TK 8 D + TK 18 D
	FM-600	–	TK 8 D	TK 8 D + TK 18 D
	FM-750	n.a.	–	TK 18 D
	FM-1000	n.a.	–	TK 18 D
	FM-1200	n.a.	–	TK 18 D
	FM-1800	n.a.	n.a.	TK 1800
2x	IM-240A	n.a.	n.a.	TK 4 DM
2x	KM-650	n.a.	n.a.	TK 4 DM
2x	KMD-201	n.a.	n.a.	TK 4 DM + TK 4 DR
2x	KMD-270	n.a.	n.a.	TK 4 DM + TK 4 DR
2x	FM-170	n.a.	n.a.	TK 4 DM
2x	FM-300	n.a.	n.a.	TK 4 DM
2x	FM-480	n.a.	n.a.	TK 4 DM
2x	FM-600	n.a.	n.a.	TK 4 DM

– = no top kit necessary
n.a. = combination of ice maker and bin is not possible.



Transport Systems



Transportation methods from Hoshizaki include a range of trolleys, carts and bagging methods that are integrated as storage compartments within the ice makers themselves. Once full, simply remove the trolley or bag full of ice, and carry or wheel it to wherever it is needed, without needing to scoop it from the machine into a receptacle.

As well as reducing the risk of contamination, these methods save valuable time that would otherwise be lost shovelling ice one scoop at a time.

It is very important that the opportunity for contamination (i.e. from human contact) is minimized, and Hoshizaki's systems do this, allowing the transportation of ice in large quantities without human manpower.

ICE TRANSPORT SYSTEMS

Model	No. of carts	Bin Capacity (kg) Approx.	Dimensions W x D x H (mm)	Weight (kg)
E-ITS-100NS-31	1	46 (+109)	787 x 1016 x 1194	110
E-ITS-500NS-31	1	174 (+109)	787 x 1016 x 1524	166
E-ITS-600NS-31	1	273 (+109)	787 x 1016 x 1702	176
E-ITS-700NS-31	1	296 (+109)	787 x 1016 x 1905	187
E-ITS-1350SG-60	2	602 (+218)	1524 x 1016 x 1905	390
E-ITS-2250SG-60	2	968 (+218)	1524 x 1016 x 2464	420



SBF

Frame Dimensions W x D x H (mm)	720 x 960 x 990
Cart W x D x H (mm)	560 x 1090 x 890
Cart Positioned in Frame W x D x H (mm)	720 x 1150 x 990

The cart requires 1100mm space to allow removal from the frame.
Optional: Additional ice cart





ICE BAGGING & DISPENSING SYSTEMS

Model	Bin Capacity Approx. (kg)	Dimensions (Including legs) W x D x H (mm)	Weight (kg)
EDB-650SA	295	857 x 1226 x 1689	209
EDB-1000SA	454	1321 x 1156 x 1823	320

ICE STORAGE & DISPENSING SYSTEMS

Model	Bin Capacity Approx. (kg)	Dimensions (Including legs) W x D x H (mm)	Weight (kg)
E-DEV-500SG-30-75	209	762 x 787 x 1600	136
E-DEV-700SG-30-75	309	762 x 787 x 1994	146

UPRIGHT STORAGE BINS

Model	Bin Capacity Approx. (kg)	Dimensions (Including legs) W x D x H (mm)	Weight (kg)
E-SG-500-30	209	762 x 787 x 1130	96
E-SG-700-30	308	762 x 787 x 1524	100

Optional:

- Additional ice cart.
- Set of 6 totes.

Also available upon request:

- Full range of stands for ice makers and storage bins.
- Ice makers with full stainless steel frames and mobile cart.
- Other storage, transport, bagging and dispensing systems.

Ice Crushers



Ice Crusher N53 is the ideal product to make crushed ice for cocktails (mojitos, frozen margaritas, daiquiris and more). To be used everywhere you need crushed ice: cocktail bars, hotels, restaurants, ice cream shops, bars and night clubs.

Powerful, efficient and reliable

- Makes both fine and coarse crushed ice in a touch of a button.
- Exceptional output: simply and quickly makes 1.2 kg of crushed ice in 30 seconds.
- Equipped with a heavy duty and quiet asynchronous motor.
- Adapted to intensive use and allows a hands free use thanks to its high capacity ice cube tank (1.2 kg).

2 functioning modes:

- Long touch on the button: manual function.
- Quick touch on the button: automatic function.
- Automatically crushes the ice placed in the tank (hands-free use).



N53

Crush Capacity (kg/min) Approx.	2.4
Storage Capacity (kg) Approx.	1.2
Dimensions W x D x H (mm)	236 x 353 x 474
Electrical Supply	1/220 - 240V/50Hz
Electrical Capacity (kW)	0,13
Weight Gross / Net (kg)	10



Sushi Cases





Product Highlights



Hoshizaki's HNC Sushi Cases are made to sit on counter tops and feature a contemporary design. Stable humidity and temperature levels are maintained at all times, instead of forced air circulation methods that dry out and ruin displayed sushi.

Hoshizaki machines will not defrost and allow condensation to drop onto the sushi displayed within them, protecting the integrity of the product at all times.



- Self-contained unit has large diameter 2.54cm drains.
- Refrigerated stainless steel glass display merchandiser.
- 8 models available from 1.2m to 2.1m.
- Condenser airflow is in the back and out the side.
- Solid food plates with radius groove to fit sushi foods.
- Large condenser face improves cooling performance.
- Top glass angles down, allowing for 170cm plate space on top of units.
- Large front to back interior 27cm.



Right Version Shown

HNC-120BE

Net Capacity (L)	42
Temperature (°C) Approx.	5
Dimensions W x D x H (mm)	1200 x 345 x 270
Electrical Supply	1/220 - 240V/50Hz
Electrical Capacity (kW)	0,15
Refrigerant	R134a
Weight Gross / Net (kg)	44/32
Compressor (Left side)	HNC-120BE-L
Compressor (Right side)	HNC-120BE-R



Left Version Shown

HNC-150BE

Net Capacity (L)	57
Temperature (°C) Approx.	5
Dimensions W x D x H (mm)	1500 x 345 x 270
Electrical Supply	1/220 - 240V/50Hz
Electrical Capacity (kW)	0,15
Refrigerant	R134a
Weight Gross / Net (kg)	52/37
Compressor (Left side)	HNC-150BE-L
Compressor (Right side)	HNC-150BE-R



Right Version Shown

HNC-180BE

Net Capacity (L)	72
Temperature (°C) Approx.	5
Dimensions W x D x H (mm)	1800 x 345 x 270
Electrical Supply	1/220 - 240V/50Hz
Electrical Capacity (kW)	0,15
Refrigerant	R134a
Weight Gross / Net (kg)	60/42
Compressor (Left side)	HNC-180BE-L
Compressor (Right side)	HNC-180BE-R



Left Version Shown

HNC-210BE

Net Capacity (L)	87
Temperature (°C) Approx.	5
Dimensions W x D x H (mm)	2100 x 345 x 270
Electrical Supply	1/220 - 240V/50Hz
Electrical Capacity (kW)	0,15
Refrigerant	R134a
Weight Gross / Net (kg)	68/47
Compressor (Left side)	HNC-210BE-L
Compressor (Right side)	HNC-210BE-R



HOSHIZAKI

Hoshizaki Europe B.V.

Tel. +31 20 6918499
Fax +31 20 6918768
sales@hoshizaki.nl

Hoshizaki UK (UK, Ireland)

Tel. +44 845 456 0585
Fax +44 132 283 8331
uksales@hoshizaki.co.uk

Hoshizaki Deutschland (Germany, Switzerland, Austria)

Tel. +49 2154/92810
Fax +49 2154/928128
info@hoshizaki.de

Hoshizaki France

Tel. +33 1 48 63 93 80
Fax +33 1 48 63 93 88
info@hoshizaki.fr

Hoshizaki Iberia (Spain, Portugal)

Tel. +34 93 478 09 52
Fax +34 93 478 08 00
info@hoshizaki.es

Hoshizaki Middle East

Tel. +971 48 876 612
Fax +971 48 876 613
sales@hoshizaki.ae

Hoshizaki Nederland

Tel. +31 20 5650420
Fax +31 20 6918768
sales@hoshizaki.nl

www.hoshizaki-europe.com

Every effort has been made to ensure that the information contained in this publication is accurate at the time of publishing. Hoshizaki Europe B.V. assumes no responsibility or liability for typographical errors or omissions or for any misinterpretation of the information within the publication and reserves the right to change without notice.